



## Fluid Dispensing Products Guide

# About Techcon

Techcon Systems was established in 1961 to service industrial manufacturing markets and has continued to be a leader in fluid dispensing systems.

In 1996 OK International acquired Techcon. This strategy provided Techcon with a strong global sales channel, with direct subsidiaries and distributors in North America, Europe and Asia.

Today, Techcon Systems represents OK International's Industrial Products Division. Currently focusing on fluid dispensing systems, Techcon's components are used in medical, automotive, telecommunications, aerospace and industrial applications throughout the world, helping improve manufacturing processes and increase customers' bottom lines.

Techcon offers a wide array of fluid dispensing products and provides dispensing components ranging from disposable accessories to complete microprocessor-controlled dispensing systems, and precision valves.

Our products are in compliance with RoHS, WEEE regulations and are meeting or exceeding CE, TUV safety standards.

Whether your goal is cost savings or process improvement, we can tailor a solution for your application.

[www.techconsystems.com](http://www.techconsystems.com)





## Table of Contents

Application Table of Contents	.2
TS250/TS350 Dispenser/Controller	.3
700 Series Dispensing Components	.4-5
Premium Dispensing Tips	.6-7
700 and 400 Series Dispensing Components	.8-9
Dispensing Tips	.10-11
Bench-Top Dispensing Robot	.12-13
TS9000 Series Jet Tech Valve	.14
TS500R Digital Controller	.15
TS5000 Rotary Microvalve	.16
TS7000 (IMP) Rotary Valve	.17
Spray Valves	.18
Diaphragm Valves	.19
Needle Valves	.20
Spool Valves	.21
Pinch Tube Valves	.22
Pressure Pot	.23
Valve Application Guide	.24-25
Dispensing Accessories	.26
Cartridges and Accessories	.27
Disposable Nozzles and Dispensing Tip Adapters	.28
Dispensing Guns	.29
Techkits	.30-31
Tutorial	.32
Valve Diagrams	.33



# Application Table of Contents

*Find the right products for your applications*



## 1. Bonding With Cyanoacrylate Application

CA is a very frequently used adhesive in the generic bonding application and it is required in a moisture resistant dispensing system. The TS5622VU Diaphragm valve along with the TS500R controller and TS1258 pressure pot is a perfect system for this application.

**TS5622VU (page 19), TS500R (page 15), TS1258 (page 23)**



## 2. Domed Logo Badges Application (Doming)

Consumer and business products often display the manufacturer's name on a sticker that is encapsulated underneath a dome of fluid. This is called "Doming" and is commonly used as this adds a better "look and feel" to the product. The TS5622VU-DVD with the TS500R controller and TS1258 pressure pot is a perfect system for this application.

**TS5622VU-DVD (page 19), TS500R (page 15), TS1258 pressure pot (page 23)**



## 3. Microdot Adhesive Dispensing

Most medical device manufacturing applications require a dispensing system that can provide a highly repeatable dispensing of UV adhesives. With the unique needle shut off design inside the dispensing tip, the TS5440 Microshot needle valve is the perfect choice for these applications. The TS500R controller is recommended for this valve.

**TS5440 Microshot needle valve (page 20), TS500R controller (page 15)**



## 4. Spray Conformal Coating Application

The TS5540 Series spray valve along with the TS500R controller and the TS1258 pressure pot is an ideal system to spray conformal coating material on the surface of an assembled printed circuit board to provide protection against moisture, dust and corrosion from extreme environments.

**TS5540 Series spray valve (page 18), TS500R controller (page 15), TS1258 pressure pot (page 23)**



## 5. Gasketing Application

When a high throughput or large shot size is required for gasketing or similar "Form-in-place-gasket" applications, the TS941 Series spool valve along with the TS350 controller is the recommended system choice. Whether the fluid is fed from a cartridge or pail pump, the TS941 Series will dispense accurately and consistently through a dispensing nozzle or dispensing tip.

For finer deposit control of sealing material, the TS5322 Series mini spool valve with the TS350 controller is recommended.

**TS941 Series spool valve (page 21), TS350 controller (page 3),**

**TS5322 Series mini spool valve (page 21)**



## 6. Dam Writing Application

The TS7000 Series rotary valve along with the TS500R controller is an ideal dispensing system to dispense the "Dam" around the die of an integrated circuit (i.c.) as an alternative method to using the pre-form molded design.

**TS7000 Series rotary valve (page 17), TS500R controller (page 15)**

## 7. Plural Component Material Dispensing

Plural component material dispensing is no longer a problem when using a Disposable Material Path valve. When the 2-component material starts to cure, just throw away the valve wetted parts. It takes less than 1 minute to replace new parts.

For low viscosity material, the TS1212 pinch tube valve along with the TS350 controller is recommended. For medium to high viscosity material with high repeatability rate requirement, the TS5000DMP valve with the TS500R controller is suitable.

**TS1212 pinch tube valve (page 22), TS350 controller (page 3),**

**TS5000DMP valve (page 16), TS500R controller (page 15)**

## 8. Solder Paste Dispensing

Solder paste is the most difficult material to dispense. The TS5000 Series rotary valve is designed specifically to dispense solder paste without clogging and separation. Dot size as small as 0.010" (0.254mm) can be dispensed consistently. A majority of automated dispensing systems incorporate the TS5000 Series valve for solder paste dispensing.

**TS5000 Series rotary valve (page 16)**





## TS250 Series Digital Dispenser/Controller

The TS250 Series Dispenser/Controller dispenses low, medium and high-viscosity fluids accurately and consistently. These systems are economical, highly accurate and repeatable micro-air dispensing systems. These user friendly fluid dispensing systems include digital timer with rotary control time knob for easy setup, and a vacuum control for all viscosities of fluids.

Packaged ready to use with a universal power supply, foot switch, air hose, sample tips, syringe barrel and adapter. Features a small footprint and is lightweight.

Available in two versions of operating pressure: 0 to 100 psi (0-6.9 bar) for general applications, and 0 to 15 psi (0-1.0 bar) for specific low viscosity applications.

Part Number	Description
TS250 Dispenser/Controller	0-100 psi (0-6.9 bar)
TS255 Dispenser	0-15 psi (0-1.0 bar)

Specifications	TS250 Series	TS350 Series
<b>Cabinet Dimensions:</b>	6"W x 6.5"L x 7.0"H 152mm x 165mm x 178mm	6"W x 6.5"L x 7.0"H 152mm x 165mm x 178mm
<b>Weight:</b>	2.6 lb. (1.2 kg)	2.6 lb. (1.2 kg)
<b>Cycle Rate:</b>	600 cycle/minute	1200 cycle/minute
<b>Timing Range:</b>	0.020-60.000 seconds	0.008-60.000 seconds
<b>Timing Repeat Tolerances:</b>	+/- 0.001%	+/- 0.001%
<b>Input Voltage:</b>	100-240 VAC	100-240 VAC
<b>Input Frequency:</b>	50-60 Hz	50-60 Hz
<b>Cycle Mode:</b>	TIMED, PURGE	TIMED, INTERRUPT, TEACH, PURGE
<b>Meets or exceeds:</b>	CE, TUV-GS and NRTL	CE, TUV-GS and NRTL
<b>Warranty:</b>	1 year	1 year



## TS350 Series Digital Dispenser/Controller

The TS350 Series Dispenser/Controller is equipped with digital timer, pressure and vacuum read out on a large LCD. The firmware provides the option of programming up to 10 varied, sequenced or individual shots. It is intuitive to use, dispenses low, medium and high-viscosity fluids accurately and consistently.

The TS350/355 Series includes a vacuum-driven "suck-back" to control material "tailing" and waste and to control drips of fluid between dispense cycles. These systems have user programmable manual (purge) and automatic dispense cycle settings (program and time) and they feature a "Teach Mode" for determining the dispensing time required when dispensing output is unknown.

Packaged ready to use with a universal power supply, foot switch, air hose, sample tips, syringe barrel and adapter. Features a small footprint and is lightweight.

Available in two versions of operating pressure: 0 to 100 psi (0-6.9 bar) for general applications, and 0 to 15 psi (0-1.0 bar) for specific low viscosity applications.

Part Number	Description
TS350 Dispenser/Controller	0-100 psi (0-6.9 bar)
TS355 Dispenser	0-15 psi (0-1.0 bar)



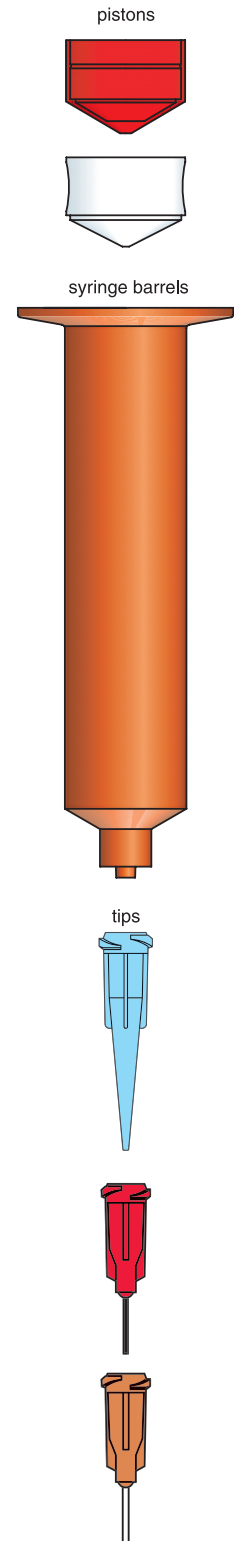

## 700 Series Dispensing Components

Our 700 Series Premier dispensing components are silicone and chloride free and designed to work with industry standard equipment. 700 Series dispensing components ensure accuracy, repeatability and productivity.

### 700 Series Syringe Barrels

Unique ultra-low draft construction of inner diameter yields high accuracy and stability. They are comprised of industry compliant silicone and chloride free, low friction polypropylene. Available in three different colors: Natural for most generic applications, amber provides protection of UV/visible light block (up to 520nm), but with the ability to see material inside the barrel; and black for total light block. Sold in bulk and packs of 50.

SIZE	NATURAL	AMBER	BLACK
3 cc	7030LL1N-1000	7030LL1D-1000	7030LL1B-1000
5 cc	7050LL1N-1000	7050LL1D-1000	7050LL1B-1000
10 cc	7100LL1N-1000	7100LL1D-1000	7100LL1B-1000
30 cc	7300LL1N-500	7300LL1D-500	7300LL1B-500
55 cc	7550LL1N-250	7550LL1D-250	7550LL1B-250

### 700 Series Air Powered Pistons

Spread the pressure evenly across, using a piston for consistent dispensing of even high viscosity material. Easy Flow pistons (blue) require less pressure to dispense and prevent air from becoming entrapped during the dispense process. Tight fit Wiper pistons (white) provide a complete seal for low viscosity fluid. Loose fit straight wall pistons (red) prevent stringing and bouncing when dispensing high viscosity material. Sold in bulk and packs of 50. Made from polyethylene.

SIZE	Wiper Piston (White)	Straight Wall Piston (Red)	Easy Flow Piston (Blue)
3 cc	7030009W-1000	7030006R-1000	7030007BL-1000
5 cc	7050009W-1000	7050006R-1000	7050007BL-1000
10 cc	7100009W-1000	7100006R-1000	7100007BL-1000
30-55 cc	7300009W-1000	7300006R-1000	7300007BL-1000



### 700 Series Syringe Barrel Kits

For your convenience these syringe barrels and white wiper pistons are packaged together without pistons inserted. Kits with Blue pistons are also available. Sold in bulk and packs of 50.

#### SYRINGE BARREL KITS WITH WHITE WIPER PISTONS

SIZE	NATURAL	AMBER	BLACK
3 cc	7030LL1NW-1000	7030LL1DW-1000	7030LL1BW-1000
5 cc	7050LL1NW-1000	7050LL1DW-1000	7050LL1BW-1000
10 cc	7100LL1NW-1000	7100LL1DW-1000	7100LL1BW-1000
30 cc	7300LL1NW-500	7300LL1DW-500	7300LL1BW-500
55 cc	7550LL1NW-250	7550LL1DW-250	7550LL1BW-250

#### SYRINGE BARREL KITS WITH BLUE WIPER PISTONS

SIZE	NATURAL
3 cc	7030LL1NBL-1000
5 cc	7050LL1NBL-1000
10 cc	7100LL1NBL-1000
30 cc	7300LL1NBL-500
55 cc	7550LL1NBL-250

### 700 Series Syringe Barrel Dimensions

CAPACITY	Overall Length A inches/mm	Outside Diameter B inches/mm
3 cc	2.96/75.18	0.46/11.56
5 cc	2.83/71.9	0.59/14.99
10 cc	3.58/90.9	0.72/18.29
30 cc	4.66/118.36	0.99/25.15
55 cc	6.91/175.51	1.01/25.65

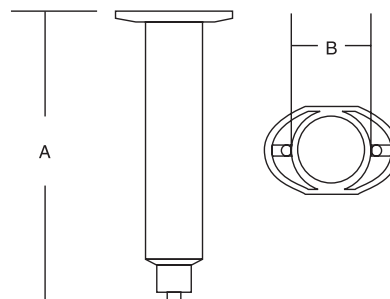



### 700 Series Tip Cap

Designed to seal the syringe barrel tip during storage and shipment. Fits all syringe barrel sizes. Sold in bulk and packs of 50. Made from polypropylene.

Part No.	Description
7015LL-1000	Tip Cap Double Helix Thread Orange
TE7015LB-1000	Tip Cap Double Helix Thread Black

### Stand up Tip Cap

Designed for easy attachment with large flat diameter at the base to allow for the syringe barrel to stand upright. Sold in bulk and packs of 50. Made from Polypropylene.



Part No.	Description
7015STC-1000	Blue Stand up Tip Cap

### 700 Series Receiver Head Assembly

Receiver Head Assemblies are the connecting link between time/pressure controllers and syringe assemblies. These assemblies provide a safe connection for accident proof dispensing. Available with 3 or 6 feet (0.9 - 1.8 meters) of tubing. Consists of receiver head with Viton O-ring, tubing and male quick connector. Sold individually. Made of Delrin®.



SIZE	3' HOSE (0.9m)	6' HOSE (1.8m)	NO HOSE
3 cc	70303RHB	70306RHB	70300RHR
5 cc	70503RHB	70506RHB	70500RHR
10 cc	71003RHB	71006RHB	71000RHR
30/55 cc	73003RHB	73006RHB	73000RHR

### In-Line Fluid Filter

Attach the fluid filter to the receiver head to prevent fluid from being pulled back from the syringe barrel into the dispenser.

Part No.	Description
881-000-000	In-line fluid filter kit
TSD800-11	In-line fluid filter only

Housing Material: Polypropylene  
 Filter Media: 0.2um PTFE  
 Operating Pressure: 75 psi max.

### Replacement O-rings for Receiver Head

Sold in packs of 10.

Receiver Head	EPR O-RING	VITON O-RING
SIZE		
3 cc	P3015EPK	P3019VPK
5 cc	P3016EPK	P3020VPK
10 cc	P3017EPK	P3021VPK
30/55 cc	P3018EPK	P3022VPK

The Receiver Head is installed with Viton O-ring.



### 700 Series End Caps

Designed to seal large end of the syringe barrel to ensure no contaminants come in contact with material during storage and shipment. Standard color is blue. Made from Polypropylene. Sold in bulk and packs of 50.

SIZE	END CAP
3 cc	703000CB-1000
5 cc	705000CB-1000
10 cc	710000CB-1000
30/55 cc	730000CB-1000



### TS700 Series Manual Syringe Gun

Lightweight syringe barrel applicator gun provides excellent control for medium/high viscosity material. Easy to use. No dripping or mess.

SIZE	MANUAL SYRINGE GUN
10 cc	TS710SG
30 cc	TS730SG

SIZE	REPLACEMENT ROD
10 cc	71000ROD
30 cc	73000ROD
55 cc	75500ROD



### Finger Switch Assembly

Use the Finger Switch with Techcon's dispensers and syringes in place of a foot pedal. Provides control at your finger tip.

Part No.	Description
DX9010	Finger Switch Assembly for TS Series Dispenser



### TE Dispensing Tips

The TE series consist of a stainless-steel cannula with a double helix polypropylene hub.

This premium line of dispensing tips is burr-free, and has an electro-polished cannula for unobstructed and consistent material flow. In addition, they are silicone and chloride free. Sold in bulk and packs of 50.

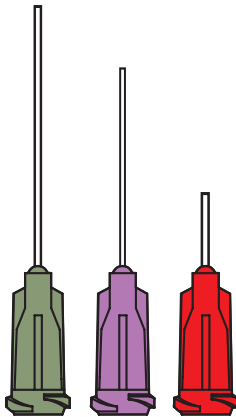

Gauge	1/4" (6.35mm)	1/2" (12.7mm)	1" (25.4mm)	1-1/2" (38.1mm)
14		TE714050-1000	TE714100-1000	TE714150-1000
15		TE715050-1000	TE715100-1000	TE715150-1000
18	TE718025-1000	TE718050-1000	TE718100-1000	TE718150-1000
20	TE720025-1000	TE720050-1000	TE720100-1000	TE720150-1000
21	TE721025-1000	TE721050-1000	TE721100-1000	TE721150-1000
22	TE722025-1000	TE722050-1000	TE722100-1000	TE722150-1000
23	TE723025-1000	TE723050-1000	TE723100-1000	TE723150-1000
25	TE725025-1000	TE725050-1000		
27	TE727025-1000	TE727050-1000		
30	TE730025-1000	TE730050-1000		
32	TE732025-1000			
34	TE734025-1000			

### TE Bent Dispensing Tips

These TE bent tips are precision bent at 45° and 90° angles. Perfect for dispensing fluid in hard to reach places. Sold in packs of 50.

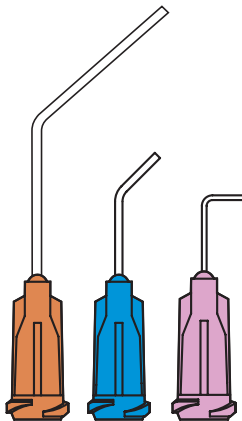

Gauge	1/2" (12.7mm)		1-1/2" (38.1mm)
	90°	45°	
14	TE714050B90PK	TE714050B45PK	TE714150B45PK
15	TE715050B90PK	TE715050B45PK	
18	TE718050B90PK	TE718050B45PK	TE718150B45PK
20	TE720050B90PK	TE720050B45PK	
21	TE721050B90PK	TE721050B45PK	TE721150B45PK
22	TE722050B90PK	TE722050B45PK	
23	TE723050B90PK	TE723050B45PK	
25	TE725050B90PK	TE725050B45PK	
27	TE727050B90PK	TE727050B45PK	
30	TE730050B90PK	TE730050B45PK	

### Color Coding and Gauge

For TE Series and TE Bent Dispensing Tips.

Color	Gauge	I.D. (")	I.D. (mm)
Olive	14	0.063	1.600
Amber	15	0.054	1.371
Green	18	0.033	0.838
Pink	20	0.024	0.610
Purple	21	0.020	0.508
Blue	22	0.016	0.406
Orange	23	0.013	0.330
Red	25	0.010	0.254
Clear	27	0.008	0.203
Lavender	30	0.006	0.152
Yellow	32	0.004	0.102
Lime Green	34	0.0037	0.095

### Teflon® Lined Tips

Teflon® lined tips are ideal for use with low viscosity fluids and cyanoacrylates (super glue) material. Benefits of using this new tip include resist cyanoacrylate clogging and prevent damage to substrates.

Teflon® lined tips feature a double helix polypropylene color hub and a rigid Teflon® crimped lining that projects approximately 1/8" (3.17mm) from the inside of a stainless steel tube. Sold in packs of 50.



Hub Color	1/2" (12.7mm)	1" (25.4mm)	Tip ID	Crimp ID
Gray	TF720050PK	TF720100PK	0.024" (0.61mm)	0.023"(0.58mm)
Pink	TF725050PK	TF725100PK	0.011" (0.28mm)	0.006"(0.15mm)



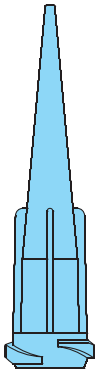

### TT Dispensing Tips

The tapered tip prevents blockage and increase the flow of high viscosity material. Standard tips are molded in high density polyethylene with UV light block additive. Rigid tips are molded in polypropylene with opaque color. Sold in bulk and packs of 50.

Gauge	Color	Standard TT Tips	Rigid TT Tips
14	Olive	TT14-DHUV-1000	TT14-RIGID-1000
16	Grey	TT16-DHUV-1000	TT16-RIGID-1000
18	Green	TT18-DHUV-1000	TT18-RIGID-1000
20	Pink	TT20-DHUV-1000	TT20-RIGID-1000
22	Blue	TT22-DHUV-1000	TT22-RIGID-1000
25	Red	TT25-DHUV-1000	TT25-RIGID-1000
27	Clear	TT27-DHUV-1000	TT27-RIGID-1000



### BT Series

Use these double helix Brush Tips for “spread” applications such as glues and other materials. Soft brush is made of Red Sable. Stiff brush is made of Nylon. Sold in packs of 12.

Gauge	Soft Bristle	Stiff Bristle
16	BT16-SOFTPK	BT16-STIFFPK
18	BT18-SOFTPK	BT18-STIFFPK
22	BT22-SOFTPK	BT22-STIFFPK

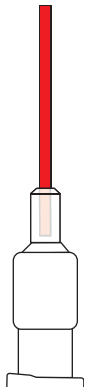

### TS-P Plastic Dispensing Tips

Flexible tips allow access to hard to reach areas and allow you to “customize” the length. Ideal for CA applications. 1<sup>1/2</sup>” length. Sold in bulk and packs of 50. Made from polypropylene.

Gauge	Color	TS-P Dispensing Tips
15	Grey	TS15P-1-1/2-500
16	Brown	TS16P-1-1/2-500
18	Pink	TS18P-1-1/2-500
20	Yellow	TS20P-1-1/2-500
22	Black	TS22P-1-1/2-500
25	Red	TS25P-1-1/2-500



### Dispensing Tip Kit

Decide for yourself which tip to use. This kit contains a variety of the most popular 700 Series tips to let you test different tips to find the ones that fit your needs.

Part No.	Description
TN00DKIT	Dispensing Tip Kit

# Manual Plungers and Pistons for 700 Series Syringe Barrels

The new manual syringe assemblies provide simple and quick dispensing solutions without the need for compressed air. Molded from Polypropylene resin, manual plungers are compatible with a wide range of dispensing fluids. Pistons are made from thermoplastic rubber and are available dry or with lubrication. Sold in packs of 50.



Part No.	Description
7030004PPK	700 Manual Plunger, 3cc
7030002MPK	700 Manual Piston Rubber, 3cc
7030002M-LUBPK	700 Manual Piston Rubber, Lub, 3cc
7050004PPK	700 Manual Plunger, 5cc
7050002MPK	700 Manual Piston Rubber, 5cc
7050002M-LUBPK	700 Manual Piston Rubber, Lub, 5cc
7100004PPK	700 Manual Plunger, 10cc
7100002MPK	700 Manual Piston Rubber, 10cc
7100002M-LUBPK	700 Manual Piston Rubber, Lub, 10cc
7300004PPK	700 Manual Plunger, 30cc
7300002MPK	700 Manual Piston Rubber, 30cc
7300002M-LUBPK	700 Manual Piston Rubber, Lub, 30cc

See pages 4 and 5 for syringes and tip caps

# 400 Series Disposable Dispensing Components

The 400 Series disposable syringes and components are available in a variety of styles to meet a wide range of applications. Sold in bulk packages only.

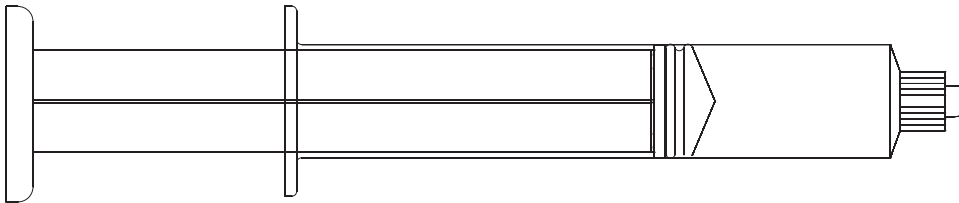

## Syringe Barrels

Barrels are molded from polypropylene. Standard style is Luer lock. Luer slip and taper tip styles are also available, however minimum quantity, lead time and pricing considerations apply. In Natural color only (for black and amber refer to page 4).



Part No.	Description
F401L-1	400 Syringe Barrel 1cc Luer Slip
403LL-1	400 Syringe Barrel 3cc Luer Lock
406LL-1	400 Syringe Barrel 6cc Luer Lock
410LL-1	400 Syringe Barrel 10cc Luer Lock
435LL-1	400 Syringe Barrel 35cc Luer Lock
460LL-1	400 Syringe Barrel 60cc Luer Lock

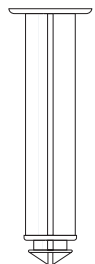

## Plungers

Part No.	Description
403L-4	3cc Plunger
406L-4	6cc Plunger
410L-4	10cc Plunger
435L-4	35cc Plunger
460L-4	60cc Plunger

## Stoppers

Rubber stoppers listed are not lubricated. For lubricated stoppers add -LUB to the part number.



Part No.	Description
401L-2	1cc Rubber Stopper, Manual
403L-2	3cc Rubber Stopper, Manual
406L-2	6cc Rubber Stopper, Manual
410L-2	10cc Rubber Stopper, Manual
435L-2	35cc Rubber Stopper, Manual
460L-2	60cc Rubber Stopper, Manual
403L-7	3cc Plastic Wiper Stopper, Manual
406L-7	6cc Plastic Wiper Stopper, Manual
410L-7	10cc Plastic Wiper Stopper, Manual
435L-7	35cc Plastic Wiper Stopper, Manual
401L-2	1cc Rubber Stopper, Air Powered
403L-2	3cc Rubber Stopper, Air Powered
406L-8	6cc Rubber Stopper, Air Powered
410L-8	10cc Rubber Stopper, Air Powered
435L-8	35cc Rubber Stopper, Air Powered
403L-9	3cc Plastic Wiper Stopper, Air Powered
406L-9	6cc Plastic Wiper Stopper, Air Powered
410L-9	10cc Plastic Wiper Stopper, Air Powered
435L-9	35cc Plastic Wiper Stopper, Air Powered
460L-9	60cc Plastic Wiper Stopper, Air Powered

# 400 Series Disposable Dispensing Components

The 400 Series disposable syringes and components are available in a variety of styles to meet a wide range of applications. Sold in bulk packages only.



## Tip Caps

Part No.	Description
15LL	Luer Lock Tip Cap
15LL-B	Black Luer Lock Tip Cap

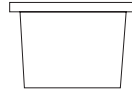

## End Caps

Part No.	Description
TS5	6cc End Cap
TS7	10cc End Cap

## Receiver Head Assemblies

The connecting link between time/pressure controllers and syringe assemblies, Receiver Head Assemblies provide a safe connection between receiver head and syringe barrel for accident proof dispensing. Receiver Head Assemblies come with no tubing (-R), 3 feet of tubing (-3) or 6 feet of tubing (-6).



## 400 Series Receiver Head Assemblies

Part No.	Size
900-250-3, -6 or -R	1cc
900-350-3, -6 or -R	3cc
900-550-3, -6 or -R	6cc
900-650-3, -6 or -R	10cc
900-950-3, -6 or -R	35cc
900-1150-3, -6 or -R	60cc

## 400 Series Manual Syringe Components

Syringe barrels and plungers are molded from polypropylene; stoppers are molded from polyethylene (-7) or thermoplastic rubber (-2). Plunger locks to the stopper for smooth, controlled manual dispensing. Use of a tip cap will seal the delivery end of the syringe barrel when not dispensing.

### Manual Syringes with Rubber Stoppers

Barrels and plungers are molded from polypropylene. Stoppers are molded from thermoplastic rubber.

Size	Syringe	Stopper	Plunger
1cc	F401L-1	401L-2	401L-4
3cc	403LL-1	403L-2	403L-4
6cc	406LL-1	406L-2	406L-4
10cc	410LL-1	410L-2	410L-4
35cc	435LL-1	435L-2	435L-4
60cc	460LL-1	460L-2	460L-4

### Manual Syringes with Plastic Stoppers

Barrels and plungers are molded from polypropylene. Stoppers are molded from polyethylene for better chemical compatibility.

Size	Syringe	Stopper	Plunger
3cc	403LL-1	403L-7	403L-4
6cc	406LL-1	406L-7	406L-4
10cc	410LL-1	410L-7	410L-4
35cc	435LL-1	435L-7	435L-4

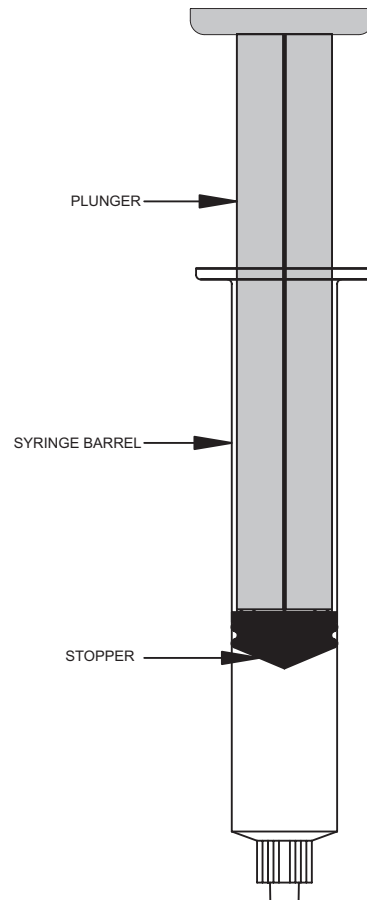

## TS Series Dispensing Tips

The TS Series Dispensing Tips offer a variety of dispensing performance and flexibility options. Stainless steel tubing is cut to precise lengths and ground to be burr-free. Cut tubing is crimped into aluminum locking insert, then molded into polyethylene hubs. Molded hub colors correspond to gauge size. All TS Series tips secure to Techcon Systems syringe barrels and correspond to the Luer lock specification.



Part Number	International Hub Color	Gauge	I.D. (inches)	I.D. (mm)	Length (inches)	Length (mm)
TS18-1/2-1000	Pink	18	0.033	0.838	0.5	12.7
TS18-1-1000	Pink	18	0.033	0.838	1.0	25.4
TS19-1/2-1000	Brown	19	0.028	0.711	0.5	12.7
TS19-1-1000	Brown	19	0.028	0.711	1.0	25.4
TS20-1/2-1000	Yellow	20	0.024	0.609	0.5	12.7
TS20-1-1000	Yellow	20	0.024	0.609	1.0	25.4
TS21-1/2-1000	Green	21	0.020	0.508	0.5	12.7
TS22-1/2-1000	Black	22	0.016	0.406	0.5	12.7
TS22-1-1000	Black	22	0.016	0.406	1.0	25.4
TS23-1/4-1000	Blue	23	0.013	0.330	0.25	6.35
TS23-1/2-1000	Blue	23	0.013	0.330	0.5	12.7
TS25-1/2-1000	Blue	25	0.010	0.254	0.5	12.7
TS27-1/4-1000	Grey	27	0.008	0.203	0.25	6.35
TS30-1/4-1000	Lavender	30	0.006	0.152	0.25	6.35
TS30-5/16-1000	Lavender	30	0.006	0.152	0.31	7.94
TS30-1/2-1000	Lavender	30	0.006	0.152	0.5	12.7

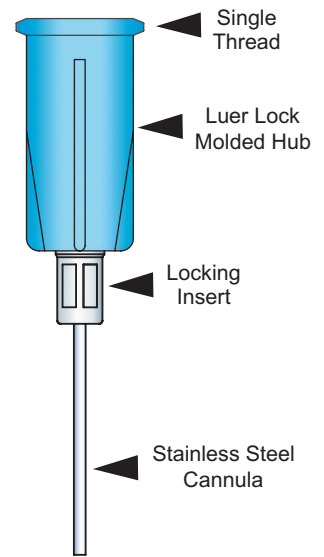

## TS-M Metal Dispensing Tips

This series consists of a stainless steel cannula and aluminium hub. Sold in bulk quantity of 500.

Part Number	Gauge	Length (inches)	Length (mm)
TS14-1/2M-500	14	0.5	12.7
TS14-1M-500	14	1.0	25.4
TS14-2M-500	14	2.0	50.8
TS15-1/2M-500	15	0.5	12.7
TS15-1M-500	15	1.0	25.4
TS15-1-1/2M-500	15	1.5	38.1
TS16-1M-500	16	1.0	25.4

## TS-SS Metal Dispensing Tips

High precision and tolerance for use in automated applications. With stainless steel cannula and nickel plated brass hub. Length of 1/2" (12.7mm). Sold in packs of 12.

Part Number	Gauge	I.D. (inches)	I.D. (mm)
TS12SS-1/2PK	12	0.087	2.21
TS13SS-1/2PK	13	0.077	1.95
TS14SS-1/2PK	14	0.061	1.54
TS15SS-1/2PK	15	0.056	1.43
TS16SS-1/2PK	16	0.048	1.22
TS17SS-1/2PK	17	0.044	1.11
TS18SS-1/2PK	18	0.033	0.83
TS19SS-1/2PK	19	0.028	0.72
TS20SS-1/2PK	20	0.024	0.62
TS21SS-1/2PK	21	0.021	0.54
TS22SS-1/2PK	22	0.017	0.42
TS23SS-1/2PK	23	0.013	0.34
TS25SS-1/2PK	25	0.011	0.27
TS26SS-1/2PK	26	0.010	0.25
TS27SS-1/2PK	27	0.008	0.21
TS28SS-1/2PK	28	0.007	0.17





# MT Series Dispensing Tips

The MT Series precision metal tapered tips deliver the best in high fluid flow rates, which are ideal for high speed dispensing, at a fraction of the cost of comparable precision tips, in the market. The smooth internal conical fluid flow path increases performance, reduces clogging and back pressure allowing for higher flow rates.



### Key Features:

- Smooth internal fluid path:
  - Reduces turbulent fluid flow
  - Reduces back pressure
  - Increases fluid flow rates.
  - Reduces air entrapment and fluid dripping
- Metal construction:
  - Provides accurate positioning
  - Ideal for automatic dispensing applications
- Thin walls – Reduces fluid tailing and stringing
- Clog resistant – ideal for filled fluids

The Phosphor-Bronze metal construction, with Electroless Nickel, plating makes the MT Series ideal for use in robotic applications or whenever precision counts. The thin walled design at the tip enhances dispensing accuracy while at the same time reduces fluid tailing and stringing. Available from 18 to 30 gauge, the MT Series tips are color coded for easy identification. Sold individually.

Part Number	Hub Color	Gauge	I.D. (inches)	I.D. (mm)	OD (inches)	OD (mm)
MT18-PBN	Pink	18	0.041	1.041	0.049	1.245
MT19-PBN	Orange	19	0.034	0.864	0.042	1.067
MT20-PBN	Green	20	0.027	0.686	0.035	0.889
MT21-PBN	Blue	21	0.024	0.609	0.032	0.813
MT23-PBN	Purple	23	0.022	0.564	0.025	0.635
MT25-PBN	White	25	0.017	0.437	0.020	0.508
MT27-PBN	Red	27	0.013	0.335	0.016	0.406
MT30-PBN	Black	30	0.009	0.233	0.012	0.305

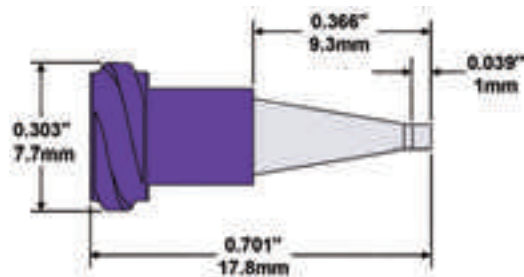



TSR2301 with TS9200

## Bench-Top Dispensing Robot

Techcon Systems bench-top dispensing robots are easy to program, simple to operate and compatible with all valve types and controllers. These versatile dispensing platforms deliver consistent, high performance dispensing results, at an affordable price.

Designed and configured specifically for fluid dispensing applications, Techcon Systems robots provide total control over fluid placement, from beads, arcs and circles to repeated timed dots. Programming is simple via teach pendant.

From a general assembly manufacturer looking to automate an existing dispensing application to an engineer designing a production process from scratch, Techcon Systems dispensing robots offers unsurpassed value in automated precision fluid dispensing.

The bench-top dispensing robot series are available in 3 platforms:

**TSR2201:** 200mm X 200mm working area

**TSR2301:** 300mm X 300mm working area

**TSR2401:** 400mm X 400mm working area

### Key Features:

- Easy to program and simple to operate
- Programmable interface via teach pendant
- Fast, increase productivity
- Compatible with all Techcon Systems syringes, valves and Jet dispensing systems.
- Suitable for wide range of fluid dispensing applications
- Rugged and reliable construction
- Small footprint
- Available in 3 platforms, from 200mm to 400mm



Teaching Pendant



TSR2201

### Typical Applications:

- Dispense dots of solder paste
- Form-in-place gasket
- Filling
- Potting
- Encapsulation
- Bonding
- Coating

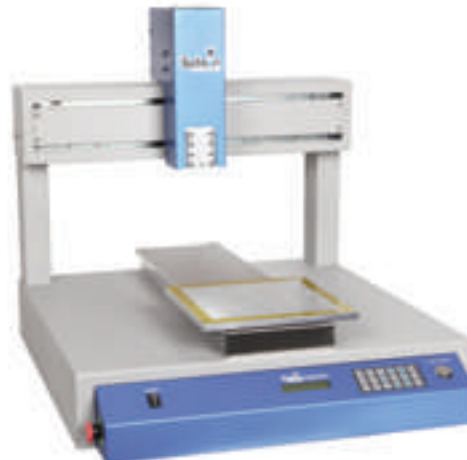

TSR2401

# Bench-Top Dispensing Robot

## Specifications:

		TSR2201	TSR2301	TSR2401
<b>Power Supply</b>		100V ~ 240V AC		
<b>Power Consumption</b>		80W		
<b>Number of Controllable Axes</b>		3 axis		
<b>Moving Range</b>	X axis	200mm	300mm	400mm
	Y axis	200mm	300mm	400mm
	Z axis	100mm	100mm	100mm
<b>Speed Range</b>	X/Y axis	0.1~600 mm/sec		
	Z axis	0.1~200 mm/sec		
<b>Repeatability Accuracy X/Y/Z axis</b>		0.02mm		
<b>Resolution X/Y/Z axis</b>		0.01mm		
<b>Loading Weight</b>	Base	5 Kg	7 Kg	7 Kg
	Head	4 Kg	4 Kg	4 Kg
<b>Working Ambient</b>	Temperature	0~40°C		
	Relative Humidity	20% - 90% (no condensation)		
<b>Dimension (W×D×H)</b>		303x377x521 mm	418x513x521 mm	518x613x521 mm

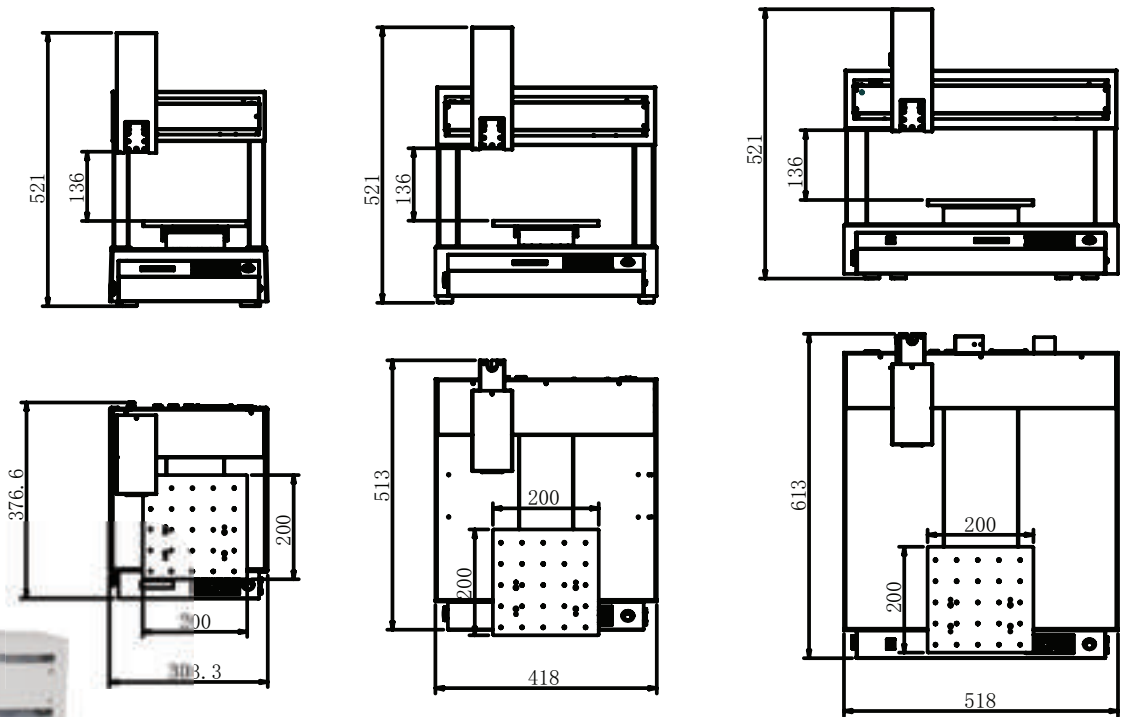

Dimensions in mm



TSR2301 with TS9000

## Accessories:

Light Beam safety cover for each model is available

- TSR2200-SC = Safety cover for TSR2201
- TSR2300-SC = Safety cover for TSR2301
- TSR2400-SC = Safety cover for TSR2401



Techcon Systems offer free application testing to make sure the TS9000 Jet Tech will meet your application requirements. Please fill out the application form on our web site [www.techconsystems.com](http://www.techconsystems.com) or e-mail us at: [application@techconsystems.com](mailto:application@techconsystems.com)

Please contact us to discuss your application needs:  
 Americas: +1 714 230 2398  
 Europe: +44 2380 489 100  
 Asia: +86 139 1613 3750

## TS9000 Series Jet Tech Valve

The TS9000 Series Jet Tech valve is a non-contact dispense valve capable of jetting low to high viscosity fluid. Jet Tech offers a fast jetting action producing hundreds of precise droplets in less than one second.

Jet Tech's compact size and modular design aids integration into robotic systems. The valve features fully adjustable parameter settings, allowing the operator to change the jetting properties for different fluid types and optimize the process for repeatable dispensing.

A variety of nozzles shape and sizes provides a wide spectrum of output jet deposits.

The TS9000 Jet Tech can be used in wide range of applications. Some examples of processes and applications are:

- Jetting silver epoxies for die bonding processes
- Jetting silicone phosphor in the LED assembly process
- Jetting under-fill in micro-electronic package applications on PCBA
- Jetting micro dots of UV adhesive in medical device applications

### Key Features:

- Non contact Jetting technology
- Extremely high speed
- Accurate and precise dispensing
- Repeatable drop size as small as 2 nl
- Capable of jetting low to high viscosity fluid
- Small modular design
- Easy and fast cleaning
- Field replaceable spare parts
- Reduces downtime
- Low total cost of ownership

### Below is a partial list of fluids that TS9000 Series Jet Tech valve has successfully dispensed:

- Alpha WS-619 Flux
- Chemiseal AF8-U1499
- Chemitech U2077ML
- Dymax 3099
- Dymax 1201-M-T-SC
- Dymax 1180-M-T-UR
- Eccobond A316-48
- Eccobond DP1005-HP
- EMI 1748S-HTG-HV3
- EMI 1768-VTG
- EMI 3553
- Henkel 3536
- Henkel 4530
- Henkel 5431
- Humiseal UV40 Series
- Hysol QMI 509
- Hysol 3800
- Hysol 3808
- Hysol 3593
- Loctite UV3103
- Loctite UV3105
- Loctite UV3106
- Loctite UV3974
- Loctite 3621
- Loctite UV 9060F
- Namics 8439
- Namics 8410
- Namics 8443
- Norland 123 TKHGA
- ThreeBond 3042C
- ShinEtzu SIFEL8470
- Cytobond
- Zymet UA-2605-B





## TS500R Multi-Purpose Digital Controller

### Cost-Effective and Productivity-Focused Multi-Purpose Digital Controller

The TS500R is the first of its type in the industry and is capable of controlling all of Techcon Systems valve series including: Pneumatic Valves, Spray Valves and Rotary Auger Valves.

With a universal power supply, it is a fully 'plug and play' system and can be used immediately, anywhere in the world, with its accompanying tools and accessories. This system uses a highly responsive air pressure management system, coupled with a digital timing circuit and display, to provide consistent, repeatable control of all types of valves.

### Key Features:

- Universal power supply with snap-on plug
- Clear 20 x 4 segments LCD display
- Classic "Rack Mount" rectangular design
- Digital timing from 0.008-60.000 seconds
- Digital pressure display in "psi" and "bar"
- +/- 0.001% Repeat timing tolerances
- 10 Programmable memories
- Adjustable low pressure alarm setting
- Controls all Pneumatic, Spray and Rotary Auger Valves (inc. Encoder Motor Valves)

### Specifications:

<b>Cabinet Dimensions:</b>	10.0"W x 7.5"D x 4.0"H (254mm x 191mm x 102mm)
<b>Weight:</b>	5.8 lb. (2.6 kg)
<b>Cycle Rate:</b>	900 cycle/minute
<b>Timing Range:</b>	0.008-60.000 seconds
<b>Timing Repeat Tolerances:</b>	+/- 0.001%
<b>AC Adaptor Input Voltage:</b>	100-240 V
<b>AC Input Frequency:</b>	50-60 Hz
<b>Cycle Mode:</b>	Timed Mode, Teach Mode, Purge Mode
<b>Meets or exceeds:</b>	CE, TUV-GS and NRTL
<b>Warranty:</b>	2 years

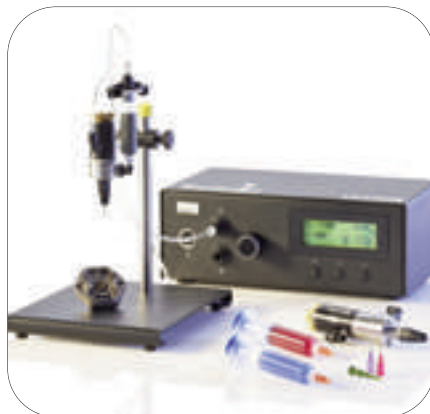



TS5000DMP - performing underfill.



Optional encoder motors are available for closed loop feed back requirement.



	Disposable Path Material	Rotating Luer Collars
6 Pitch	DMP6-10	DMP6R-10
8 Pitch	DMP8-10	DMP8R-10
16 Pitch	DMP16-10	DMP16R-10

Sold in packs of 10.

## TS5000DMP Rotary Microvalve

The Rotary Valves use a rotary feed screw (auger) to dispense fluid with a positive displacement action, allowing for ultra-precise control of the dispensing process. The unique design ensures that material is constantly present at the feed screw inlet, while the controlled rotation of the feed screw moves the material from the feed to the discharge point. Discrete control of the forward and reverse rotations of the feed screw controls the amounts of material discharged.

The unique DMP (Disposable Material Path) Valve (TS5000DMP) offers a choice of 3 different feed screw sizes (6, 8 and 16-pitch), all made of Delrin®. The DMP Valve has a hinged doorway that opens easily so the disposable auger can be removed and replaced within seconds, while the line is still in operation, significantly reducing downtime and waste. The choice of left, right or center hinge openings makes the valve suitable for mounting on most automated systems.

### Typical Applications:

Solder paste, die attach, surface mount adhesive, chip encapsulation, dam writing, two-part epoxy, UV adhesive.

### Key Features:

- Precise and consistent shot sizes
- Motor reverse capability
- Field replaceable wetted parts
- Adjustable dispense rate
- Closed-loop motor control with encoder feedback (encoder version)

#### TS5000DMP

<b>Length:</b>	5.88" (149mm)
<b>Width:</b>	3.56" (90mm)
<b>Weight:</b>	0.77 lb. (350 g)
<b>Wetted Parts:</b>	Delrin®, Viton®, Nylon
<b>Max Fluid Pressure:</b>	30 psi (2.1 bar)
<b>Material Inlet:</b>	Female Luer Lock
<b>Material Outlet:</b>	Male Luer Lock
<b>Mounting:</b>	1.0" (25.4mm) Wide Channel
<b>Recommended Viscosity Range:</b>	30K - 1300K cps



TS5000 Disposable path available in 3 different pitches, and with 3 different rotating Luer collars.



TS5000DMP Right hand opening. Left and front door opening also available.

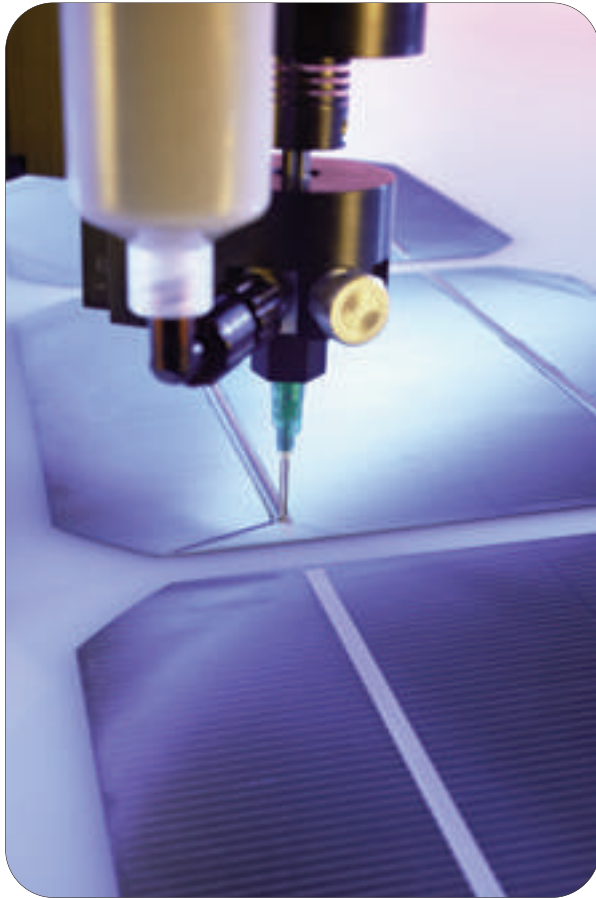

*TS7000IMP- solar cell tabbing*

## TS7000 Interchangeable Material Path (IMP) Rotary Valve

The TS7000 Series IMP Rotary Valves are the latest additions to the Rotary Microvalve family. The valve uses a feed screw (auger) to dispense fluid with a rotary displacement action, allowing ultra-precise control of the dispensing process. The valve's modular design allows quick and easy replacement of the feed screw/chamber cartridge assembly without removing the valve from the machine. In addition, the valve cartridge can be interchanged to use with TS5000DMP feed screw inserts.

The TS7000 Series IMP valve is available in 4 choices of feed screw sizes (32-pitch, 16-pitch, 8-pitch and high output 8-pitch), all made of precision hardened tool steel. An encoder motor version is available for applications that require closed-loop motor control with encoder feed back.

### Typical Applications:

Solder Paste, Die Attach, Surface Mount Adhesive (SMA), Chip Encapsulation, Dam Writing, Thermal Grease.

### Recommended Controller:

TS500R Digital Controller

### Key Features:

- Accurate and repeatable dispensing output
- Precision and durable feed screw/chamber
- Field replaceable spare parts
- Quick and easy feed screw/chamber cartridge changeover
- Low-maintenance design
- Interchangeable with TS5000DMP valve body
- Flexible syringe mounting position
- Flexible needle installation position
- Flexible encoder position (encoder version)
- Closed-loop motor control with encoder feed back (encoder version)

### Valves:

PART NUMBER	DESCRIPTION
TS7000-32	IMP Rotary Valve, 32-Pitch
TS7000-16	IMP Rotary Valve, 16-Pitch
TS7000-8	IMP Rotary Valve, 8-Pitch
TS7000-8HO	IMP Rotary Valve, 8-Pitch High Output
TS7000E-32	IMP Rotary Valve, 32-Pitch, Encoder
TS7000E-16	IMP Rotary Valve, 16-Pitch, Encoder
TS7000E-8	IMP Rotary Valve, 8-Pitch, Encoder
TS7000E-8HO	IMP Rotary Valve, 8-Pitch High Output, Encoder

### Cartridge Assembly:

PART NUMBER	DESCRIPTION
7090-9140	Cartridge Assembly, 32-Pitch
7090-9040	Cartridge Assembly, 16-Pitch
7090-9030	Cartridge Assembly, 8-Pitch
7090-9050	Cartridge Assembly, 8-Pitch HO

### Specifications:

<b>Length:</b>	6.78" (172.2mm)
<b>Width:</b>	3.70" (94mm)
<b>Depth:</b>	2.23" (56.6mm)
<b>Weight:</b>	0.86 lb. (390 g)
<b>Wetted Parts:</b>	Hardened Tool Steel, Stainless Steel, UHMWPE, Nylon
<b>Mounting:</b>	1.0" (25.4mm) Wide Channel
<b>Recommended Viscosity Range:</b>	30K - 1300K cps



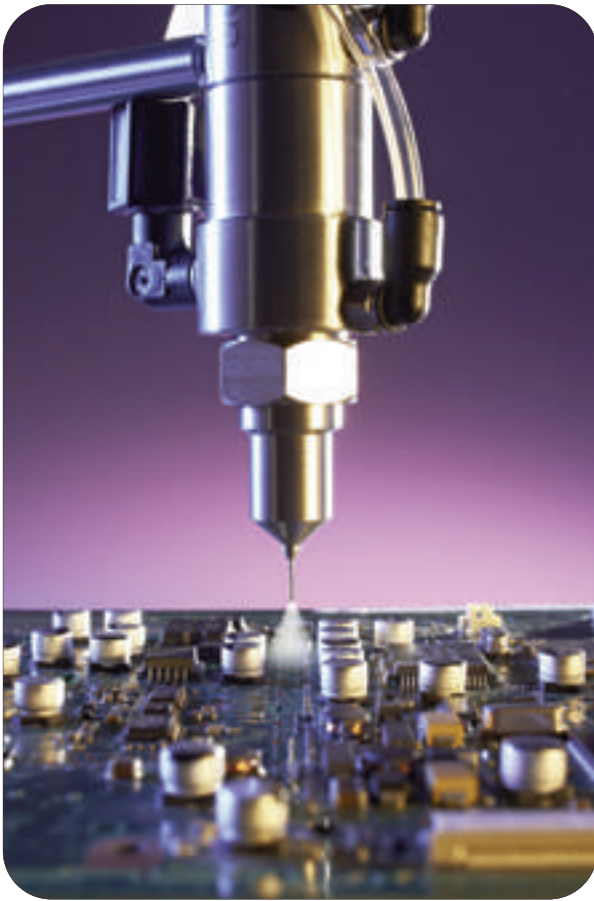

**TS5540-MS** - spraying conformal coating.

## TS5500 Series Spray Valves

The Spray Valves are designed for precise spray applications of low viscosity materials. Total control of the spray cycle is provided by adjustable fluid flow and precise control of pre-spray, atomizing air and post-spray with the TS500R Valve Controller. Normal maintenance is simple and downtime is virtually eliminated with only one seal to replace.

The TS5540 Spray Valves come with FDA-Compliant 303 stainless steel construction in both air cylinder and fluid housing. A field replaceable Delrin® seat provides positive shut-off and extends life cycles. The compact design and easy-mount threaded hole allow for easy integration into automated applications.

### Key Features:

- Consistent spray coverage with no overspray
- Positive shut-off
- Adjustable flow control
- Long life cycles

### Typical Applications:

To spray fine mist of low viscosity fluids such as: conformal coating, solvent, oil, etc.

Valve Specifications	TS5520	TS5540
<b>Length:</b>	4.2" (107mm)	4.2" (107mm)
<b>Diameter:</b>	1.12" (28mm)	1.12" (28mm)
<b>Weight:</b>	0.3 lb. (136 g)	0.74 lb. (336 g)
<b>Wetted Parts:</b>	303 SS, Teflon®, EPR, Anodized Al, Delrin®	303 SS, Teflon®, Delrin®
<b>Viscosity Range:</b>	1-1k cps	1-5k cps
<b>Max Fluid Pressure</b>	100 psi (6.9 bar)	
<b>Activation Pressure:</b>	70 psi (4.8 bar) Minimum	
<b>Connections:</b>	Inlet: 1/8" NPT Outlet: Spray nozzle	
<b>Mounting:</b>	1/4" 20UNC-2B	



**TS5540**  
Spray Valve  
with Cone Nozzle



**Cone Nozzle**



**TS5540**  
Spray Valve  
with Fan Nozzle



**Fan Nozzle**



**TS5520**  
Spray Valve  
with Cone Nozzle



**NEW TS5540-MS**  
Microshot Spray  
Valve

### Valves with Nozzles:

	Opening Diameter	Cone Nozzle	Fan Nozzle
<b>TS5520</b>	0.046" (1.17mm)	Standard	Not available
<b>TS5540</b>	0.014" (0.356mm)	TS5540-014R	TS5540-014F
	0.028" (0.711mm)	TS5540-028R	TS5540-028F
	0.046" (1.17mm)	TS5540-046R	TS5540-046F

### Nozzles only:

Opening Diameter	Cone Nozzle	Fan Nozzle
0.014" (0.356mm)	RNC014	FNC014
0.028" (0.711mm)	RNC028	FNC028
0.046" (1.17mm)	RNC046	FNC046

### TS5540-MS Microshot Spray Valve

The TS5540-MS spray valve is designed to spray low viscosity materials through disposable dispensing tips. Spray patterns range from 0.18" - 0.60" (4.6mm-15mm) in diameter.

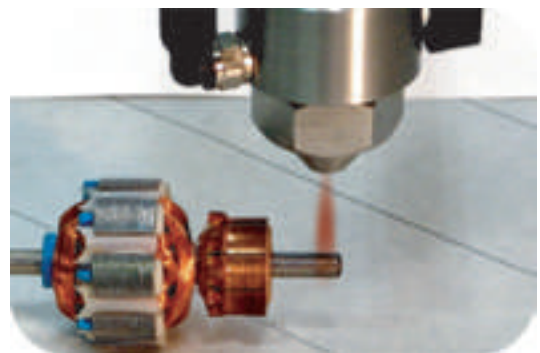



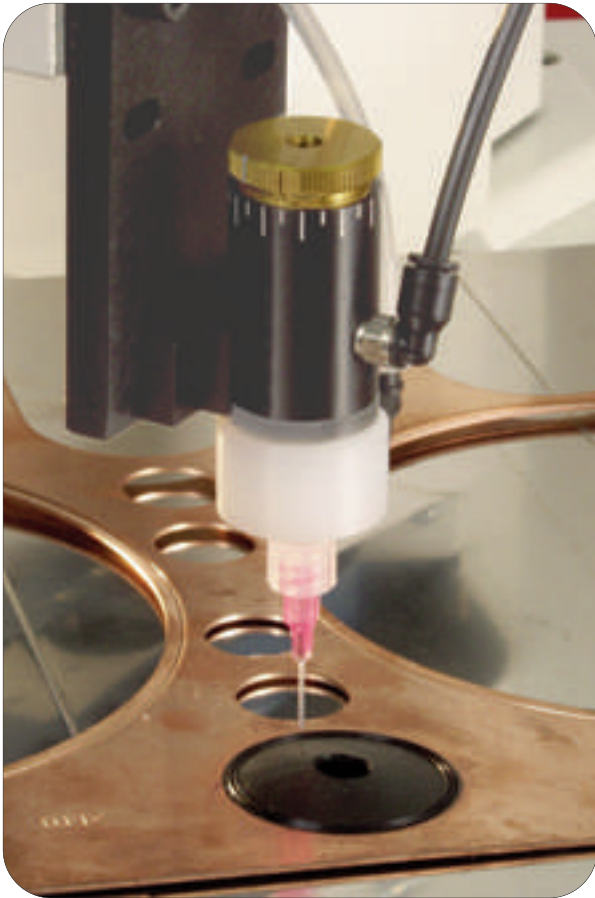

TS5622 - dispensing cyanoacrylate.

## TS5620 Series Diaphragm Valves

Diaphragm Valves are designed to dispense low to medium viscosity materials with precision accuracy over a wide range of shot and bead sizes down to a fraction of a micro liter. A short opening stroke provides fast, positive shut-off. An external stroke control adjustment makes it easy to fine-tune shot sizes. The compact design allows for mounting flexibility and easy integration into automated applications.

Body available in FDA-compliant Ultra High Molecular Weight Polyethylene (UHMWPE) for most applications. A Teflon® version for chemical compatibility, and a Delrin® version for UV-curables are also available. A stainless steel version with optimized internal fluid route is especially dedicated to dispense UV-cure adhesives, resins and lacquers used in the manufacture of DVDs and CDs. A hand-held actuated valve is also available. The valves are easy to use and maintain with user replaceable spare parts.

### Key Features:

- Excellent moisture sensitive resistance
- Adjustable stroke control
- Compact size and weight
- Simple and low maintenance design
- Long life cycles

### Typical Applications:

To dispense a wide range of shot sizes of low viscosity fluids such as: cyanoacrylates, anaerobics, liquid fluxes, solvents, UV-cure adhesives, resins and lacquers.

<b>Length:</b>	2.4" (61mm) - 3.47" (88mm) (Depending on exact configuration)
<b>Diameter:</b>	0.94" (24mm) - 1.06" (27mm)
<b>Weight:</b>	0.13 lb. (59 g) to 0.26 lb. (118 g)
<b>Wetted Parts:</b>	Depending on exact configuration
<b>Viscosity Range:</b>	1-50k cps
<b>Max Fluid Pressure:</b>	70 psi (4.8 bar)
<b>Activation Pressure:</b>	70 psi (4.8 bar) - 90 psi (6.2 bar)
<b>Connections:</b>	Depending on exact configuration
<b>Mounting:</b>	10-32 UNF (not available on handheld models)

PART NUMBER	DESCRIPTION
TS5620HU	Horizontal valve UHMWPE
TS5621HD	Horizontal valve Delrin®
TS5620HT	Horizontal valve Teflon®
TS5622VU	Vertical Valve UHMWPE
TS5622VD	Vertical Valve Delrin®
TS5622VT	Vertical Valve Teflon®
TS5622VU-DVD	Vertical Valve, UHMWPE and Stainless Steel
TS5623HU	Hand Held Valve UHMWPE
TS5623HD	Hand Held Valve Delrin®
TS5623HT	Hand Held Valve Teflon®





## TS5400 Series Needle Valves

Needle Valves dispense very precise deposits over a wide range of shot and bead sizes due to a minimal dead fluid zone. An external stroke control adjustment to fine-tune shot sizes. Easy to maintain, with little or no downtime. The compact design and easy-mount threaded hole allows for easy integration into automated applications.

The TS5420 Adjustable Needle Valve is a pneumatically triggered single-acting valve that can be used with an integral spring close (single action) or may be connected for air closing without the spring (double acting).

The TS5440 Microshot Needle Valve, with its needle closing the fluid path directly on the cannula inside the dispensing tip hub, can dispense very precise deposits down to 0.0005 cm<sup>3</sup>.

### Key Features:

- Precise and consistent shot sizes
- Adjustable flow control
- Zero dead fluid zone
- Simple and low maintenance design

### Typical Applications:

To dispense microdots of low viscosity fluids such as: solvents, inks, oils, activators, primers; the TS5440 is excellent to dispense microdots of UV adhesive used in medical device manufacturing.

TS5440 - dispensing medical device adhesive



TS5420  
Needle Valve



TS5440  
Microshot  
Needle Valve

Valves:	TS5420	TS5420SS	TS5440
<b>Size and Weight</b>	L: 4.4" (112mm) D: 1.12" (28mm) Weight: 0.3 lb. (136 g)	L: 4.4" (112mm) D: 1.12" (28mm) Weight: 0.5 lb. (227 g)	L: 5.0" (127mm) D: 1.12" (28mm) Weight: 0.5 lb. (227 g)
<b>Wetted Parts</b>	303 SS, Anodized Al, Teflon®, EPR, Delrin®	303 SS, Teflon®, EPR, Delrin®	303 SS, Teflon®, EPR
<b>Maximum Fluid Pressure</b>	300 psi (20.7 bar)	300 psi (20.7 bar)	100 psi (6.9 bar)
<b>Activation Pressure</b>	70 psi (4.8 bar) Minimum	70 psi (4.8 bar) Minimum	70 psi (4.8 bar) Minimum
<b>Connections</b>	Inlet: 1/8" NPT Outlet: Male Luer Lock	Inlet: 1/8" NPT Outlet: Male Luer Lock	Inlet: 1/8" NPT Outlet: Taper w/ Luer Lock
<b>Mounting</b>	1/4"-20UNC-2B	1/4"-20UNC-2B	10-32 UNF
<b>Recommended Viscosity Range</b>	1-100k cps	1-100k cps	1-100k cps





TS941 - gasketing.

## TS941 High Pressure Spool Valve

The Spool Valves provide precise shot accuracy along with “high volume” capacity over a range of material viscosities, shot sizes and pressures. They feature “suck back” anti-drip as well as a fast on/off dispensing function that is not affected by material input pressure. An optional oil chamber creates an additional liquid seal to prevent moisture from being carried on the spool, excellent for moisture sensitive materials. Pneumatically activated, the valves can be used with an internal spring close (single acting) or an air-closing connection (double acting).

Output is a 1/4" NPT which allows multiple types of tips to be used.

## TS5322 Mini Spool Valve

The Mini Spool Valve Series is designed for better accuracy with lower pressure. The series operates similar to the TS941, however, it is smaller in size.

	TS941	TS5322
<b>Length:</b>	4.7" (119mm)	4.00" (101.6mm)
<b>Diameter:</b>	1.5" (38mm)	1" (25mm)
<b>Weight:</b>	1.61 lb. (726 g)	0.31 lb. (141 g)
<b>Wetted Parts:</b>	303 Stainless Steel, UHMWPE, EPR	303 Stainless Steel, Anodized Al, Teflon®, EPR
<b>Viscosity Range:</b>	5 - 3000k cps	5 - 1000k cps
<b>Max Fluid Pressure:</b>	2500 psi (172.4 bar)	500 psi (34.5 bar)
<b>Activation Pressure:</b>	70 psi (4.8 bar)	70 psi (4.8 bar)
<b>Material Inlet:</b>	3/8" NPT	1/8" NPT
<b>Material Outlet:</b>	1/4" NPT	1/8" NPT
<b>Mounting:</b>	1.50" Diameter	1/4"-20UNC-2B

### Typical Applications:

Suitable for moisture sensitive adhesive when utilizing supplied oiler. The Spool Valves can be used in a wide range of applications such as flux paste, grease, RTV Silicone, UV cure gel, solder mask, gasketing.



TS941  
Spool Valve



TS5322  
Mini Spool Valve



TS5322 - gasketing.





## TS1212 Pneumatic Pinch Tube Valve

Provides control for continuous or micro shot applications of low to semi-viscous fluids. The "ON/OFF" control is achieved by automatically opening and closing (pinching) a molded polyethylene tube assembly. Adjusting the opening size of the pinch tube assembly determines the shot size or flow rate. In addition, the air actuated valve can be timed to develop desired shot sizes. Finally, a wide range of dispensing tips can be used to further refine the amount of dispensed output. The only part of the valve making contact with the fluid being dispensed is the disposable pinch tube assembly. Replacement pinch tube assemblies are sold in packages of 10.

### Key Features:

- Disposable fluid path
- Simple to operate
- Compact size and weight

### Typical Applications:

Cyanoacrylates, anaerobics, two-part adhesive, etc.

<b>Length:</b>	2.49" (63mm)
<b>Diameter:</b>	1.58" (40mm)
<b>Weight:</b>	0.18 lb. (82 g)
<b>Wetted Parts:</b>	Polyethylene (standard), Polyurethane (optional)
<b>Viscosity Range:</b>	1-45k cps
<b>Max Fluid Pressure:</b>	60 psi (4.1 bar)
<b>Material Inlet:</b>	Female Luer Lock
<b>Material Outlet:</b>	Male Luer Lock
<b>Mounting:</b>	1/4"-20UNC-2B
<b>Activation Pressure:</b>	50 psi (3.4 bar) minimum

## Spare Pinch Tube for TS1212

Sold in packs of 10.

Part Number	Material	I.D.	Connection
1212-004-002BPK	Black PE	0.1" (2.54mm)	Male to Female
1212-004-002PK	Natural PE	0.1" (2.54mm)	Male to Female
1212-004-000PK	Natural PE	0.07" (1.78mm)	Male to Female
1212-004-100BPK	Black PU	0.125" (3.18mm)	Male to Female
1212-004-100PK	Natural PU	0.125" (3.18mm)	Male to Female



## TS1201 Dispense Pen

The TS1201 Dispensing Pen uses a disposable molded tube assembly. Designed to handle a wide variety of fluids – from adhesives and lubricants to sealants and masks. Gravity or pressure fed, the pen has a built-in shot and flow rate for repeatability. Includes pre-assembled applicator pen, two clear and two black spare pinch tube assemblies, an assortment of disposable dispensing tips and a 24" (0.61m) hose. Replacement pinch tube assemblies sold in packs of 10.

### Key Features:

- Disposable fluid path
- Simple to operate
- Compact size and weight

### Typical Applications:

Cyanoacrylates, anaerobics, two-part adhesive, etc.

<b>Length:</b>	5" (127mm)
<b>Diameter:</b>	1.34" (34mm)
<b>Weight:</b>	0.08 lb. (36 g)
<b>Wetted Parts:</b>	Polyethylene (standard), Polyurethane (optional)
<b>Viscosity Range:</b>	1-45k cps
<b>Max Fluid Pressure:</b>	60 psi (4.1 bar)
<b>Material Inlet:</b>	Female Luer Lock
<b>Material Outlet:</b>	Male Luer Lock

## Spare Pinch Tube for TS1201

Sold in packs of 10.

Part Number	Material	I.D.	Connection
1201-000-004BPK	Black PE	0.1" (2.54mm)	Male to Female
1201-000-004PK	Natural PE	0.1" (2.54mm)	Male to Female
1201-000-006PK	Natural PE	0.07" (1.78mm)	Male to Female
1201-006-000PK	Natural PU	0.125" (3.18mm)	Male to Female





TS1258



NEW TS1254



## Pressure Pot

The Pressure Pot is designed to accommodate low to medium viscosity fluid, including solvents, adhesives, as well as CAs and UVs. The fluid feed line is located in the center of the unit for direct and continuous feed path from the reservoir to the The TS1258 is shipped with a 1/4" tubing and the TS1254 is shipped with a 6mm tubing. For use with the TS1212 or TS1201 valve, a TS1252-4MM Fluid Line kit is needed.

	<b>TS1258</b>
<b>Size:</b>	10" x 15.1" (254 x 383mm)
<b>Chamber:</b>	6.1" I.D. x 11.0" (155 I.D. x 280mm)
<b>Weight:</b>	21 lb. (9.5 kg)
<b>Max Operating Pressure:</b>	100 psi (6.9 bar)
<b>Internal Volume:</b>	5 liters

	<b>TS1254</b>
<b>Size:</b>	7.5" X 12.5" (190 X 318mm)
<b>Chamber:</b>	4.75" I.D. x 6.5" (121 I.D. x 165mm)
<b>Weight:</b>	10.4 lb. (4.7 kg)
<b>Max Operating Pressure:</b>	70 psi (4.8 bar)
<b>Internal Volume:</b>	1.8 liters

**Available Fluid Line Kits:** Includes clear and black tubing

**FOR THE TS1258 PRESSURE POT**

<b>TS1252-4MM</b>	4mm O.D. tube (required for TS1212 and TS1201 connection)
<b>TS1258-250</b>	1/4" O.D. tube
<b>TS1258-375</b>	3/8" O.D. tube

**FOR THE TS1254 PRESSURE POT**

<b>TS1252-4MM</b>	4mm O.D. tube (required for TS1212 and TS1201 connection)
<b>1254-250PE</b>	6mm O.D. tube PE

## TS918-46 Four-way Manifold

Designed to provide equal flow for up to four fluid paths, the TS918-46 is used whenever precision fluid flow to multiple stations is required. The Manifold works with the TS1258 Pressure Pot (TS1258-375 Hose Kit required to use TS918-46 and TS1258 together). Made from Delrin® and suitable with UV materials. The manifold can be used with any Techcon Systems Valve.

<b>Size:</b>	2.6" x 2.2" (66 x 56mm)
<b>Inlet Port:</b>	1/4" NPT (3/8" O.D. tube fitting is included)
<b>Outlet Port:</b>	1/8" NPT (4 Luer Lock fittings are included)
<b>Max Operating Pressure:</b>	100 psi (6.9 bar)
<b>Mounting:</b>	1/4"-20UNC-2B (x2)

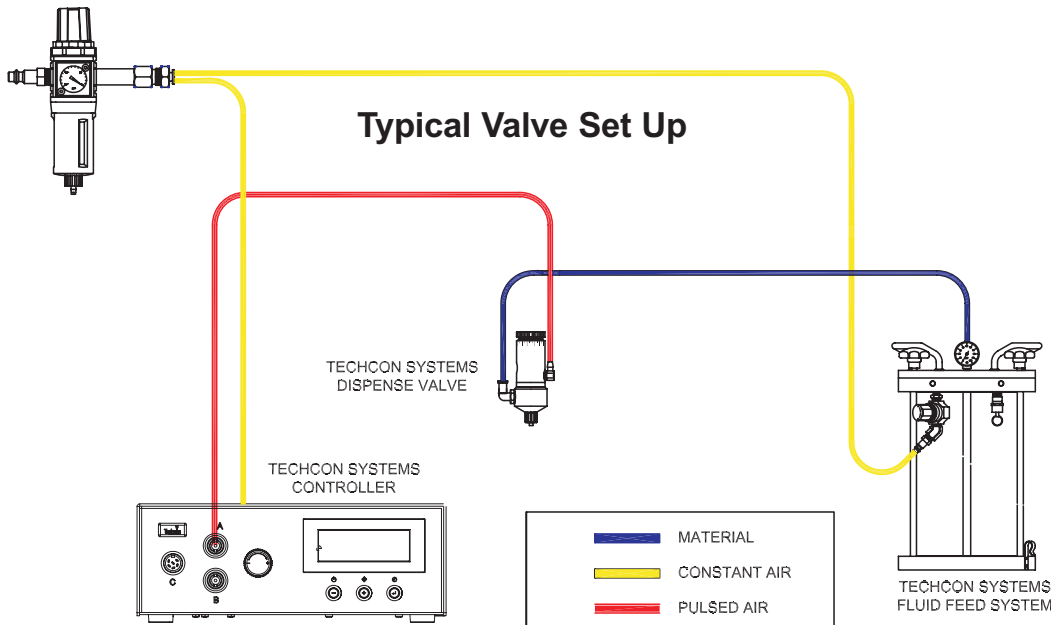

# Valve Application Guide

Valve Version	Pinch (TS1212)	Needle (TS5420)	Micro Needle (TS5440)	Mini Spool (TS5322)	HP Spool (TS941)	Diaphragm (TS5620)	Rotary DMP (TS5000DMP)	Rotary (TS7000)	Spray (TS5540)	Jet (TS9000)
Micro shots	X	◆	●	◆	X	◆	◆	●	X	●
Dots	●	●	●	●	●	●	●	●	X	●
Lines/Beads	●	●	●	●	●	●	●	●	X	●
Potting & Encapsulation	◆	◆	◆	●	●	●	●	●	X	X
Packaging/Filling	●	●	●	●	●	●	◆	◆	X	X
High Pressure	X	X	X	●	●	X	X	X	X	X
Sprayed	X	X	X	X	X	X	X	X	●	X
Jetting	X	X	X	X	X	X	X	X	X	●
<b>VISCOSITY</b>										
High	X	X	X	●	●	X	●	●	X	●
Medium	X	X	◆	●	●	X	●	●	X	●
Low	●	●	●	◆	◆	●	X	X	●	●
<b>APPLICATION</b>										
Activators	●	●	●	◆	◆	●	X	X	●	●
Alcohol	●	●	●	◆	◆	●	X	X	●	◆
Anaerobics	●	X	X	X	X	●	●	X	X	X
Brazing Paste	X	X	X	X	X	X	X	●	X	X
Conformal Coatings	X	◆	◆	◆	◆	●	X	X	●	◆
Cyanoacrylates	●	X	X	X	X	●	X	X	X	X
Epoxies	◆	◆	◆	◆	◆	X	●	●	X	●
Flux (liquid)	●	●	●	◆	◆	●	X	X	●	●
Flux (paste)	X	X	X	●	●	X	●	●	X	●
Greases	X	X	◆	●	●	X	●	●	X	●
Inks	●	●	●	◆	◆	●	X	X	●	◆
Lacquers	◆	◆	●	◆	◆	●	X	X	●	●
Mold Releases	●	●	●	◆	◆	●	X	X	●	X
Oils	●	●	●	◆	◆	●	X	X	●	●
Paints	●	●	●	◆	◆	●	X	X	●	●
Reagent	◆	●	●	X	X	●	X	X	●	●
RTV Silicone	X	X	X	●	●	X	●	●	X	◆
Solder masks	●	◆	◆	●	●	●	X	X	X	●
Solder pastes	X	X	X	◆	◆	X	◆	●	X	X
Solvents	●	●	●	X	X	●	X	X	●	●
Two-part adhesive	●	X	X	X	X	X	●	X	X	X
UV cure adhesive (liquid)	◆	X	●	◆	X	●	X	X	●	●
UV cure adhesive (gel)	X	X	●	●	X	X	●	●	X	●
UV cure with anaerobic	●	X	X	X	X	●	●	X	X	X

EXCELLENT ●

AVERAGE ◆

DO NOT USE X

# Fluid Dispensing Valves

Techcon Systems offers a wide range of fluid dispensing valves from simple manual dispensing to precision valves for high speed automated applications. The range of valves includes:

- Disposable material path valves for use with difficult materials.
- Easily maintained precision shot valves with excellent accuracy over a wide range of viscosities, material pressures and shot sizes.
- High speed valves for the precise deposit of heavy viscosity filled pastes and highly abrasive materials.

Techcon Systems offers a wide array of valve choices to meet every fluid dispensing need. Users are encouraged to utilize the “Techcon Material Test Program” to help define the appropriate valve for standard and unique applications. See our web site or contact Techcon Systems to access this unique and complimentary service. The following charts display the variety of valve features available.

Recommended = ●

Valve Type	Viscosity Range			Small shot Accuracy by Viscosity Range			Disposable Material Path	Field Replaceable wetted parts	High Flow Rate	High Feed Pressure	Aggressive Material	Abrasive Material	Atomizing Spray
	Low	Med	High	Low	Med	High							
TS1201	●						●	●			●		
TS1212	●						●	●			●		
TS941		●	●					●	●	●	●		
TS5322		●	●		●	●		●		●			
TS5420	●			●				●			●		
TS5440	●	●		●	●			●			●		
TS5540/5520	●							●			●		●
TS5622	●			●				●			●		
TS5000DMP		●	●		●	●	●	●				●	
TS7000		●	●		●	●		●			●	●	
TS9000/9200	●	●	●	●	●	●		●			●	●	

Viscosity Rating; Low = Up to 30K Cps; Med = 30K-100K Cps; High = 100K Cps - up

## Production Master Systems



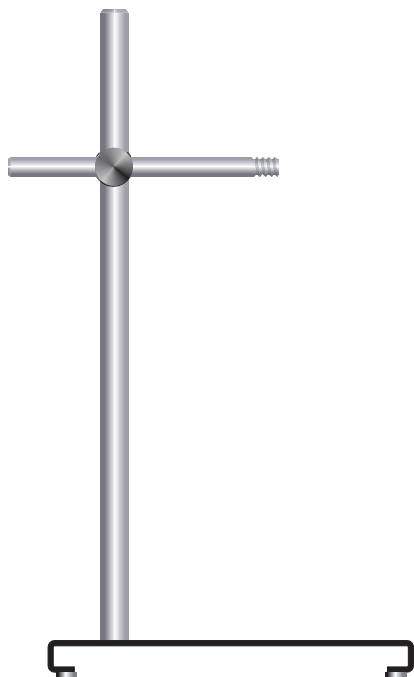

Production Master Systems provide added flexibility and productivity for hands-free, remotely controlled dispensing. It incorporates a unique “building block” concept to provide more versatility in specific dispensing applications. The system consists of a basic production master stand, mounting rod, brackets and a rod clamp.



Part Number	Description
918-033-000	Production Master Stand (Base and Support)
918-000-011	Syringe Bracket for 400 Series
918-000-013	TS934/TS941 Spool Valve Bracket
918-110-004	1/10 gallon (325ml) Cartridge Bracket
918-000-007	2.5 oz. (74ml), 6 oz. (177ml), 8 oz. (237ml) and 12 oz. (355ml) Cartridge Bracket
918-000-039	20 oz. (591ml) Cartridge Bracket
918-000-012	Rod Clamp Assembly
918-000-009	6" Non-Threaded Mounting Rod
1212-000-008	6" 1/4-20UNC-2B Threaded Mounting Rod
5620-000-008	4" 10-32 Threaded Mounting Rod
5000-000-005	TS5000DMP/TS7000IMP Mounting Bracket

## Fluid Line Assemblies

Each polyethylene hose assembly is provided with a molded Luer lock fitting on one or both ends. The assembly can be used with other standard Luer lock connectors and will handle up to 100 psi (6.9 bar) working pressure.

	PART NUMBER	SIZE	CONNECTION	MATERIAL
	TSD126-118PK	0.100" (2.54mm) x 18" (457mm)	Male Luer/open	Natural PE
	TSD126-124PK	0.100" (2.54mm) x 24" (610mm)	Male Luer/open	Natural PE
	TSD126-136PK	0.100" (2.54mm) x 36" (914mm)	Male Luer/open	Natural PE
	TSD126-218PK	0.100" (2.54mm) x 18" (457mm)	Female Luer/open	Natural PE
	TSD126-224PK	0.100" (2.54mm) x 24" (610mm)	Female Luer/open	Natural PE
	TSD126-236PK	0.100" (2.54mm) x 36" (914mm)	Female Luer/open	Natural PE
	TSD126-318PK	0.100" (2.54mm) x 18" (457mm)	Male Luer/female Luer	Natural PE
	TSD126-318BPK	0.100" (2.54mm) x 18" (457mm)	Male Luer/female Luer	Black PE
	TSD126-324PK	0.100" (2.54mm) x 24" (610mm)	Male Luer/female Luer	Natural PE
	TSD126-324BPK	0.100" (2.54mm) x 24" (610mm)	Male Luer/female Luer	Black PE
	TSD126-336PK	0.100" (2.54mm) x 36" (914mm)	Male Luer/female Luer	Natural PE
	TSD126-336BPK	0.100" (2.54mm) x 36" (914mm)	Male Luer/female Luer	Black PE
	TSD126-360BPK	0.100" (2.54mm) x 60" (1524mm)	Male Luer/female Luer	Black PE
	TSD126-418PK	0.100" (2.54mm) x 18" (457mm)	Female Luer/female Luer	Natural PE
	TSD126-424PK	0.100" (2.54mm) x 24" (610mm)	Female Luer/female Luer	Natural PE
	TSD126-436PK	0.100" (2.54mm) x 36" (914mm)	Female Luer/female Luer	Natural PE
	TSD126-524PK	0.100" (2.54mm) x 24" (610mm)	Male Luer/male Luer	Natural PE

## Luer Lock Fittings

All 931 Series fittings are molded and have good chemical resistance to solvents, acids and resin fluids. The locking end accepts all standard dispensing tips and molded fitting used on the TSD126 Series hose assemblies. For a complete list, contact your local representative.

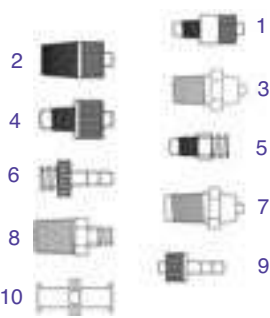
	PART NUMBER	DESCRIPTION	MATERIAL	
	1	TSD931-5	Male Luer Lock to 5/16"-28	White Acetal
	2	TSD931-6	Male Luer Lock to 1/8" NPT	White Acetal
	3	TSD931-7	Male Luer Lock to 1/4" NPT	White Polypropylene
	4	TSD931-8	Male Luer Lock to 1/4"-32	White Acetal
	5	TSD931-9	Female Luer Lock to 1/4"-32	White Acetal
	6	TSD931-13	Female Luer Lock to Hose Barb	White Acetal
	7	TSD931-14	Male Luer Lock to 1/4" NPT	Black Polypropylene
	8	TSD931-15	Female Luer Lock to 1/4" NPT	Black Nylon/Acetal
	9	TSD931-17	Male Luer Lock to Hose Barb	White Acetal
	10	TSD931-28	Female Luer Lock to Female Luer Lock	Natural Polypropylene

## Compression Fittings & Tubes

Compression fittings and tubes provide secure connection and increase fluid flow.

	PART NUMBER	DESCRIPTION	MATERIAL
	TSD1003-16	1/8" NPT to 1/4" O.D. tube, 90° fitting	Black Polypropylene
	TSD1002-17	1/8" NPT to 3/8" O.D. tube fitting	Black Polypropylene
	TSD1002-18	1/8" NPT to 1/4" O.D. tube fitting	Black Polypropylene
	TSD1002-38	1/4" NPT to 1/4" O.D. tube fitting	Black Polypropylene
	TSD1566-5	1/4" NPT to 3/8" O.D. tube fitting	Black Polypropylene
	TSD1099-22	3/8" O.D. x 1/4" I.D. tube	Black Polyethylene
	TSD1099-23	3/8" O.D. x 1/4" I.D. tube	Clear Polyethylene
	TSD1099-24	1/4" O.D. x 1/8" I.D. tube	Clear Polyethylene
	TSD1099-25	1/4" O.D. x 1/8" I.D. tube	Black Polyethylene
	TSD1099-45	6mm O.D. x 4mm I.D. tube	Clear Polyethylene
TSD1099-46	6mm O.D. x 4mm I.D. tube	Black Polyethylene	



# Cartridges and Accessories

These dependable, high quality products are designed for the rigors of manufacturing and have undergone continuous improvement to keep pace with the exacting requirements of this challenging field.

Disposable plastic cartridges and nozzles provide a clean, efficient and low-cost method to meet all types of production requirements. Plungers with a wiper leading edge clean each cartridge thoroughly. Caps and plugs for both ends of the cartridge are available, making the system ideal for prepackaged materials as well as pre-mixed and frozen material handling.



Cap

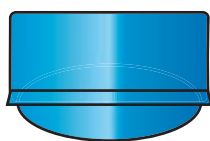

Plunger

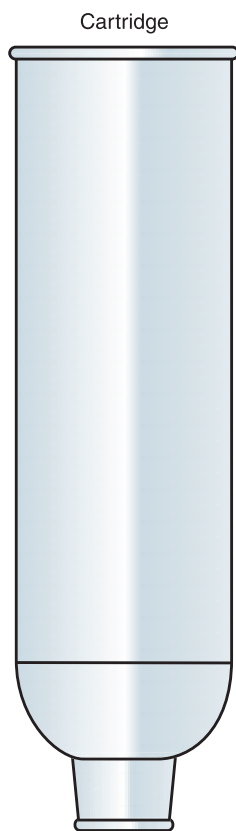

Cartridge

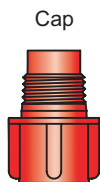

Cap

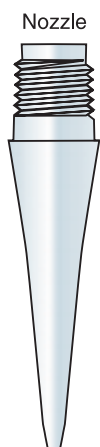

Nozzle

## Cartridges

Cartridges are available in 2 1/2, 6, 8, 12, and 20 ounce as well as 1/10 gallon capacities. Each size can be used with hand or bench mounted air powered dispensing tools or manual dispensing tools. Cartridges are molded in either standard or low density polyethylene. Custom colors are available. Sold in bulk packages.

Part Number	Description	Length Inches/mm	Diameter Inches/mm
TS25C-500	2.5 oz. (74ml) Natural HDPE	4.00/101.6	1.59/40.4
TS25C-LD-500	2.5 oz. (74ml) Natural LDPE	4.00/101.6	1.59/40.4
TS60C-500	6 oz. (177ml) Natural HDPE	7.11/180.6	1.59/40.4
TS60C-BLACK-500	6 oz. (177ml) Black HDPE	7.11/180.6	1.59/40.4
TS60C-LD-500	6 oz. (177ml) Natural LDPE	7.11/180.6	1.59/40.4
TS80C-250	8 oz. (237ml) Natural HDPE	8.92/226.6	1.59/40.4
TS80C-LD-250	8 oz. (237ml) Natural LDPE	8.92/226.6	1.59/40.4
TS120C-250	12 oz. (355ml) Natural HDPE	12.34/313.4	1.59/40.4
TS120C-BLACK-250	12 oz. (355ml) Black HDPE	12.34/313.4	1.59/40.4
TS120C-LD-250	12 oz. (355ml) Natural LDPE	12.34/313.4	1.59/40.4
TS110C-250	1/10 Gallon (325ml) Natural HDPE	8.99/228.3	1.85/47.0
TS110C-LD-250	1/10 Gallon (325ml) Natural LDPE	8.99/228.3	1.85/47.0
TS20C-100	20 oz. (591ml) Natural HDPE	10.3/254.8	2.57/65.3
TS20C-BLACK-100	20 oz. (591ml) Black HDPE	10.3/254.8	2.57/65.3

## Plungers

Wiper Plungers incorporate a modified or extended front wiper edge. Sold in bulk packages.

Part Number	Description
TS1P-SR-1000	2.5, 6, 8, 12 oz., Blue Wiper LDPE
TS1PB-SR-1000	2.5, 6, 8, 12 oz., Black Wiper LDPE
TS1WP-1000	2.5, 6, 8, 12 oz., Natural Extended Wiper LDPE
TS3WP-MD-1000	2.5, 6, 8, 12 oz., Natural Reduced Wiper MDPE
TS2PW-1000	1/10 Gallon White Extended Wiper LDPE with EVA
TS2P-BLACK-1000	1/10 Gallon Black Wiper LDPE
TS20P-100	20 oz. White Wiper MDPE
TS20PLD-100	20 oz. Natural Wiper LDPE

## Caps

Top and bottom Caps provide a choice of methods to seal the neck and base of the cartridge. Sold in bulk packages.

Part Number	Description
TS2C-1000	2.5, 6, 8, 12 oz. Red LDPE Flange Cap
TS4C-1000	1/10 Gallon Red LDPE Flange Cap
TS6C-1000	20 oz. Red LDPE Flange Cap
TS3P-1000	Threaded Tri Seal Red PE Cap
TS4P-1000	Threaded Square Red PE Cap
TS5P-1000	Snap On Tri Seal Red PE Cap
TS6P-BLACK-1000	Threaded Black PE Cap
TS6P-RED-1000	Threaded Red PE Cap
TS9X-1000	Push On Red PE Cap

LD = Low Density  
MD = Medium Density

HD = High Density  
PE = Polyethylene

EVA = Ethylene Vinyl Acetate



# Disposable Nozzles and Dispensing Tip Adapters

Nozzles and dispensing tip adapters provide a wide range of application capabilities. Standard nozzles may be cut back to increase orifice size.

## Dispensing Tip Adapters

These tip adapters have standard 1/4" NPT male threads on one end to fit all Techcon Systems cartridges or equivalent and standard male Luer lock threads on opposite side to fit all Luer lock dispensing tips.

Part Number	Description
TSD931-7	Dispensing Tip Adapter White Polypropylene
TSD931-14	Dispensing Tip Adapter Black Polypropylene
918-006-000	Dispensing Tip Adapter Metal

## Standard Nozzles

Standard nozzles are precision molded from natural polyethylene and have 1/4" NPT male threads to fit all Techcon Systems cartridges or equivalent. Sold in bulk package of 1000. These nozzles can be ordered with 30, 45, 80 and 90 degree bends, however minimum order, lead time and pricing considerations apply.

Part Number	Description
TS216-1000	2.5" 1/16" (63.5mm/1.59mm) Orifice, HDPE
TS218-1000	2.5" x 1/8" (63.5mm/3.18mm) Orifice, HDPE
TS218-LD-1000	2.5" x 1/8" (63.5mm/3.18mm) Orifice, LDPE
TS416-HO-HD-1000	Nozzle 4" X 1/16" Orifice, HD, HO, qty = 1000
TS416-HO-LD-1000	Nozzle 4" X 1/16" Orifice, LD, HO, qty = 1000
TS418-HO-LD-1000	Nozzle 4" X 1/8" Orifice, LD, HO, qty = 1000
TS432-HO-HD-1000	Nozzle 4" X 1/32" Orifice, HD, HO, qty = 1000
TS432-HO-LD-1000	Nozzle 4" X 1/32" Orifice, LD, HO, qty = 1000
TS490-HO-LD-1000	Nozzle 4" X 3/32" Orifice, LD, HO, qty = 1000
TS616-HO-LD-1000	Nozzle 6" X 1/16" Orifice, LD, HO, qty = 1000
TS618-HO-LD-1000	Nozzle 6" X 1/8" Orifice, LD, HO, qty = 1000

## Bent Nozzles

Please go to [www.techconsystems.com](http://www.techconsystems.com) for the full range:

Part Number	Description
TS416-HO-LD-B30/1-1000	Nozzle, 4" X 1/16, HO, LD, Bent 30° at 1", qty = 1000

## Specialty Nozzles

Specialty nozzles are precision molded from polyethylene and have 1/4" NPT male threads to fit all Techcon Systems cartridges or equivalent. Available in various thicknesses and widths to meet your application needs. Sold in bulk package of 1000.

Part Number	Description
TS1050-1000	4" (101.6mm) Spreader Nozzle 1/2" x 1/16" (12.7mm x 1.59mm) Opening
TS1050-45-1000	4" (101.6mm) Spreader Nozzle 45 Deg 1/2" x 1/16" (12.7mm x 1.59mm) Opening
TS1075-1000	4.5" (114.3mm) Spreader Nozzle 3/4" x 1/8" (19.05mm x 3.18mm) Opening
TS1100-1000	4.4" (111.76mm) Spreader Nozzle 1" x 1/8" (25.4mm x 3.18mm) Opening
TS1175-1000	4" (101.6mm) Spreader Nozzle 1-3/4" x 1/8" Opening
TS3106-1000	4" (101.6mm) Fillet Nozzle 3/8" x 1/8" (44.45mm x 3.18mm) Opening, Right Step
TS3206-1000	4" (101.6mm) Fillet Nozzle 3/8" x 1/8" (9.53mm x 3.18mm) Opening, Left Step

LD = Low Density  
MD = Medium Density  
HD = High Density  
PE = Polyethylene

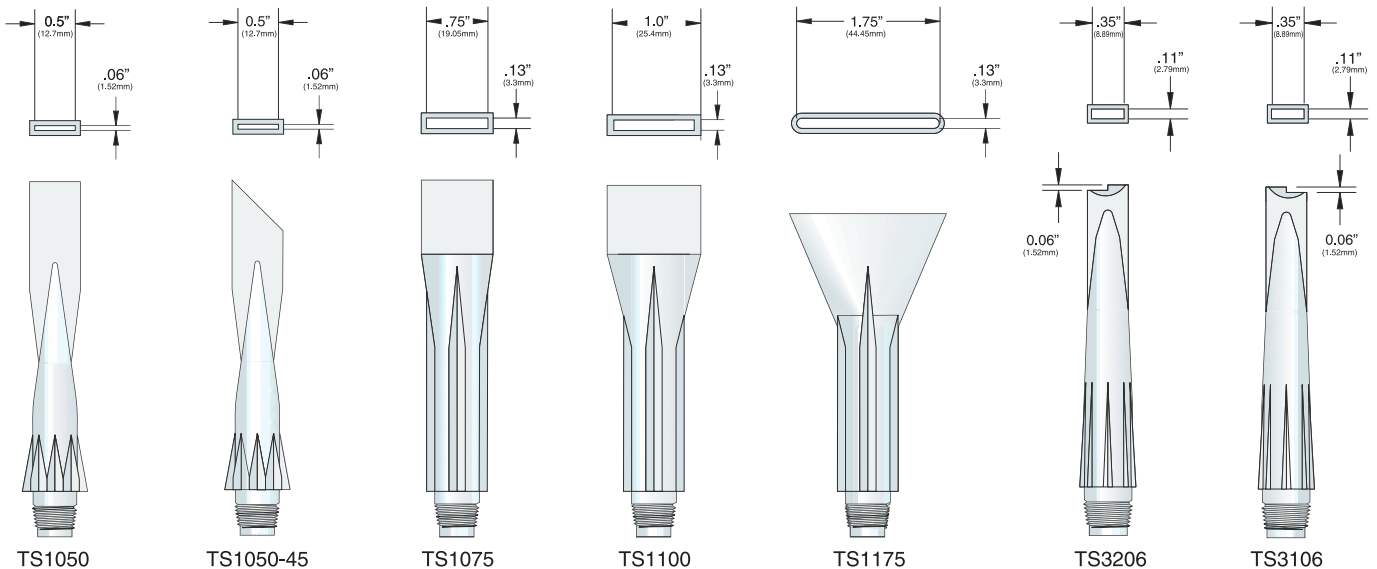



## G Series Dispensing Guns and Components

Techcon Systems G Series guns and components are designed to accommodate standard 1/10 gallon cartridges, such as Techcon's TS110C. Techcon also provides metal retainers that adapt the G Series handle assemblies for use with the smaller diameter cartridges. A 20 oz. retainer with adapter is available to accommodate the 20 oz. cartridge.

### G Series Retainer

The G Series retainers provide up to 100 psi (6.9 bar) air pressure.

Part Number	Size
110-2	1/10 gal. (325ml)
101-25R	2.5 oz. (74ml)
101-60R	6 oz. (177ml)
101-120R	12 oz. (355ml)
101-20R*	20 oz. (591ml)
101-20A	20 oz. Adapter (591ml)

\*101-20A Adapter is required for 20 oz.

### G Series Retainer Cap

The G Series retainer cap provides a leak-proof connection between the dispenser and G Series retainers. Shipped complete with air hose assembly, and can withstand up to 70 psi (4.8 bar) pressure.

Part Number	Description
918-000-036	G Series Retainer Cap

### G Series Gun Assemblies

This pneumatic pistol grip G Series gun provides infinite control of line or dot dispensing and can withstand up to 100 psi (6.9 bar) pressure. Shipped complete with a 10-foot air hose.

Part Number	Size	Handle	Retainer
G-110	1/10 gal. (325ml)	110-1-10	110-2
G110-25	2.5 oz. (74ml)	110-1-10	101-25R
G110-60	6 oz. (177ml)	110-1-10	101-60R
G110-120	12 oz. (355ml)	110-1-10	101-120R
G110-20*	20 oz. (591ml)	110-1-10	101-20R

\*101-20A Adapter included.

### TS910 Tube Dispense Gun

The TS910 gun is ideal for dispensing RTV silicones, grease or other material that contain in collapsible tube. Shipped complete with 5 foot (1.5 meters) air hose, quick connect fitting, nozzle and locking nut.

Part Number	Size
TS910	3 to 5 fluid oz. (89 -148ml)

## TS Series Dispensing Guns and Components

TS Series dispensing guns and components are designed to accommodate Techcon Systems extensive line of Cartridges and Techkits.

### TS Retainers

The TS Series retainers are durable, lightweight and can withstand up to 100 psi (6.9 bar) pressure.

Part Number	Size
918-030-000	2.5 oz. (74ml)
918-031-000	6 oz. (177ml)
918-034-000	8 oz. (237ml)
918-032-000	12 oz. (355ml)

### TS Retainer Cap

The TS Series retainer cap provides a leak-proof connection between the dispenser and TS Series retainers. Quick connector and air hose assembly are available separately and can withstand up to 100 psi (6.9 bar) pressure.

Part Number	Description
918-001-004	TS Series Retainer Cap
918-000-002	Air Hose Assembly
534	Connector with Shut-off
534A	Connector without Shut-off

### TS16 Manual Gun Assemblies

The lightweight TS16 Series manual gun assembly is ideal for field applications where compressed air is unavailable.

Gun	Size	Handle	Retainer
TS16-25	2.5 oz. (74ml)	TS16	918-030-000
TS16-60	6 oz. (177ml)	TS16	918-031-000
TS16-80	8 oz. (237ml)	TS16-2	918-032-000
TS16-120	12 oz. (355ml)	TS16-2	918-032-000

### TS950 Sealant Gun

The TS950 is a versatile, pneumatic sealant gun designed to accommodate all TS Series retainers. Complete assembly includes palm grip gun with pistol grip handle attached. Shipped without air hose, the 1000-12 ten-foot hose assembly can be ordered separately.

Pistol Grip Sealant Gun	Size	Palm Grip Assembly	Pistol Grip Handle	Retainer
TS950-25-HA	2.5 oz. (74ml)	TS950-75	TS950-3	918-030-000
TS950-60-HA	6 oz. (177ml)	TS950-75	TS950-3	918-031-000
TS950-80-HA	8 oz. (237ml)	TS950-75	TS950-3	918-034-000
TS950-120-HA	12 oz. (355ml)	TS950-75	TS950-3	918-032-000

# Techkit Cartridge Mixers

## TS6500 Series

The TS6500 Series cartridge mixer provides complete automatic mixing of two-component material filled in a cartridge kit. The feature rich TS6500 Series accommodates all standard size cartridge kits ranging from 2.5 oz (74ml) to 20 oz. (591ml) and is immediately usable anywhere in the world with its accompanying tools, accessories and universal power supply.

### Key Features:

- Universal power supply for worldwide use
- Automatic fluid level sensing device for all kit sizes— No need to set stroke length
- Automatically injects hardener into resin to provide uniform mixed material
- Robust, high torque motor to handle high viscosity material
- Safety features include safety enclosure, emergency stop button and two-hand start
- User programmable manual and automatic mixing cycle settings
- 10 programmable memories for storing and recalling most frequently used mix cycle
- Quick and easy to replace cartridge holder and plunger - No tool needed
- User friendly firmware for easy setup
- Robust and sturdy platform for heavy industrial used
- RoHS, WEEE compliance

### Specifications:

<b>Size:</b>	15.7"W x 21.2"D x 40.6"H 398mm x 538mm x 1032mm
<b>Weight:</b>	80 lb (36kg)
<b>Internal Voltage:</b>	120-230VAC, 50-60 Hz, 2 Amp
<b>Motor Speed:</b>	139 RPM
<b>Air Inlet:</b>	80 psi (5.5 Bar) Min.
<b>Stroke Speed:</b>	33 Strokes/minute (fully extended)
<b>Meets or exceeds:</b>	CE, cTUV-us
<b>Warranty:</b>	1 year

Part number	Description
<b>TS6500CIM-6</b>	Cartridge Mixer for 2.5 (74ml), 6 oz. (177ml), 8 oz. (237ml) kit
<b>TS6500CIM-20</b>	Cartridge Mixer for 20 oz. (591ml) kit
<b>CK6500-6</b>	Conversion Kit for 2.5, 6, 8 oz. kit
<b>CK6500-10</b>	Conversion kit for 1/10 gal kit
<b>CK6500-20</b>	Conversion kit for 20 oz. kit



## Techkits

### Two Component Cartridge Packaging and Mixing Kits

The Techkit is a compact and simple method of packaging two or three component resin systems into a 2 1/2, 6, 8, 20 ounce or 1/10 gallon cartridge. The kit mechanically separates the base and hardener until they are ready to be used. An internal mixing head provides a thorough blend for all types of compounds. When the job has been completed, the entire package is disposed of: no clean up or physical contact with the resin. Reliability is increased with accurate compound ratios, complete mixing and proper application techniques.

Three types of kits are available:



### Barrier Type

For compounds with a Minimum demand of 23ml Hardener the catalyst and base are separated by an aluminum barrier formed over the mixing head

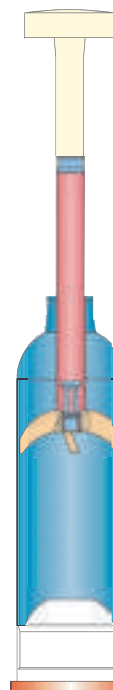

### Injection Type

For compounds with a Maximum demand of 12.5ml or less the catalyst is contained inside the valved mixing rod while the base is in the cartridge.

### Barrier/Injection Type

For three component compounds, components of both Injection and Barrier are combined.



# Techkit Components

## Mix Heads

Part Number	Description
110-340	1/10 gal. (325ml) Mix Head
110-350	1/10 gal. (325ml) Foiled Mix Head
600-200	Open Mix Head
600-300	Wheel Mix Head
600-310	Foiled Wheel Mix Head
600-320	Half Closed Circle Mix Head
600-330	Foiled Half Closed Circle Mix Head
600-360	20 oz. (591ml) Wheel Mix Head
600-370	20 oz. (591ml) Foiled Wheel Mix Head
600-380	20 oz. (591ml) Spoked Wheel Mix Head

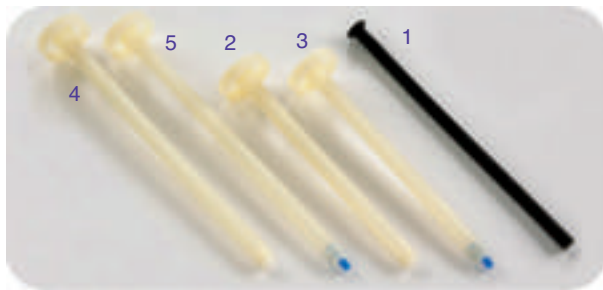

## Rods

Part Number	Description
1 600-080	8" (203.2mm) Ram Rod
2 600-100	6" (152.4mm) Plugged Rod
3 610-100A	6" (152.4mm) Valved Rod with Piston
4 800-100	8" (203.2mm) Plugged Rod
5 810-100A	8" (203.2mm) Valved Rod with Piston

## Complete Techkits

Part Number	Size	Type	Cartridge	Plunger	Cap	Mix Head	Rod	Ram Rod
110-80	1/10 gal. (325ml)	Injection	TS110C	TS2PW	TS4C	110-340	810-100A	600-080
110-81	1/10 gal. (325ml)	Barrier	TS110C	TS2PW	TS4C	110-350	800-100	
110-81T	1/10 gal. (325ml)	Taped Barrier	TS110C	TS2PW	TS4C	110-350	800-100	
250-60	2 1/2 oz. (74ml)	Injection	TS25C	TS1WP	TS2C	600-200	610-100A	600-080
250-61	2 1/2 oz. (74ml)	Barrier	TS25C	TS1WP	TS2C	600-310	600-100	
250-61T	2 1/2 oz. (74ml)	Taped Barrier	TS25C	TS1WP	TS2C	600-310	610-100	
250-80	2 1/2 oz. (74ml)	Injection	TS25C	TS1WP	TS2C	600-200	810-100A	600-080
250-81	2 1/2 oz. (74ml)	Barrier	TS25C	TS1WP	TS2C	600-310	800-100	
250-81T	2 1/2 oz. (74ml)	Taped Barrier	TS25C	TS1WP	TS2C	600-310	800-100	
600-60	6 oz. (177ml)	Injection	TS60C	TS1WP	TS2C	600-200	610-100A	600-080
600-61	6 oz. (177ml)	Barrier	TS60C	TS1WP	TS2C	600-310	600-100	
600-61T	6 oz. (177ml)	Taped Barrier	TS60C	TS1WP	TS2C	600-310	600-100	
600-80	6 oz. (177ml)	Injection	TS60C	TS1WP	TS2C	600-200	810-100A	600-080
600-81	6 oz. (177ml)	Barrier	TS60C	TS1WP	TS2C	600-310	800-100	
600-81T	6 oz. (177ml)	Taped Barrier	TS60C	TS1WP	TS2C	600-310	800-100	
800-80	8 oz. (237ml)	Injection	TS80C	TS1WP	TS2C	600-200	810-100A	600-080
800-81	8 oz. (237ml)	Barrier	TS80C	TS1WP	TS2C	600-310	800-100	
800-81T	8 oz. (237ml)	Taped Barrier	TS80C	TS1WP	TS2C	600-310	800-100	
200-80	20 oz. (591ml)	Injection	TS20C	TS20P	TS6C	600-360	810-100A	600-080
200-81	20 oz. (591ml)	Barrier	TS20C	TS20P	TS6C	600-370	800-100	
200-81T	20 oz. (591ml)	Taped Barrier	TS20C	TS20P	TS6C	600-370	800-100	

## Sealant Smoothing and Removal Tools

Techcon Systems plastic sealant tools are ideal for spreading, smoothing and removing sealants or adhesives. Approved for use in aerospace industry, these tools are designed to prevent damage to delicate substrates. Spatulas made from Nylon. Smoothing tool made from Celcon®.

PART NUMBER	DESCRIPTION
1275-000-001	Spatula, Large
1275-000-002	Spatula, Medium
1275-000-003	Spatula, Small
TS1275-KP	Spatula Kit
TS1275-4	Smoothing tool, Red Celcon®





# Tutorial

## Time-Pressure Dispensing

Time pressure dispensing is the most common dispensing method used today. Its popularity stems from the need for process control and the fact that it is possible to dispense from disposable containers without the need for cleaning.

Our time-pressure dispensers deliver a measured amount of air pressure, for a measured amount of time, to a pre-filled syringe barrel. This controlled shot of air pressure forces material out of the delivery end of the barrel, through a dispensing tip, and out to the application surface.

### Factors Affecting Dispensing

- **PRESSURE:** Increasing fluid pressure will increase dot size and vice versa
- **TIME:** Increasing dispense time will increase dot size and vice versa
- **DISPENSING TIP SIZE:** Larger inside diameter (orifice) needle results in bigger dot size

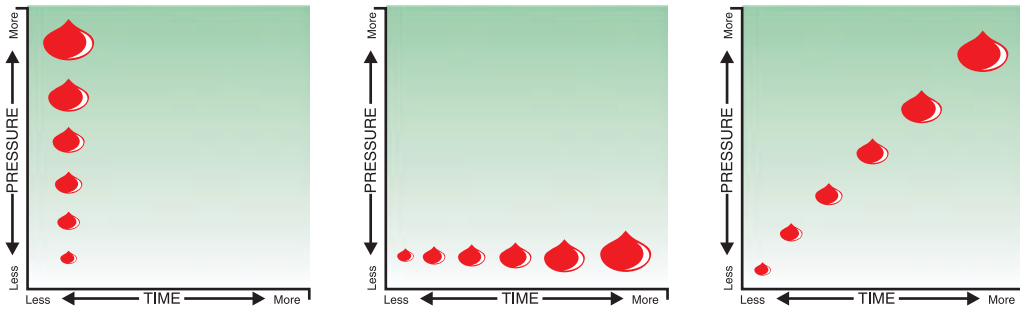
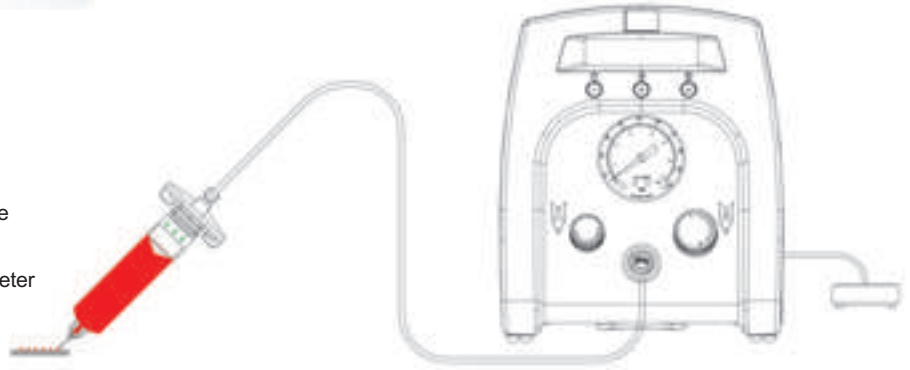

### Basic Dispensing Guidelines

- **SMALL SHOT SIZE** = small dispensing tip, low fluid pressure, short dispense time
- **LARGE SHOT SIZE** = larger dispensing tip, higher fluid pressure, longer dispense time
- **LOW VISCOSITY FLUID** = small dispensing tip, low pressure, time as required
- **HIGH VISCOSITY FLUID** = larger dispensing tip (tapered dispensing tip recommended), high pressure, time as required
- Position syringe barrel at 45° angle
- Position the dispensing tip close to the work surface then activate the dispense cycle and keep the syringe barrel in the same position until the cycle is completed
- If vacuum "suck-back" is needed, use only enough vacuum to draw back fluid into the dispense tip. Excessive vacuum could draw air into the fluid and also could draw fluid into the dispenser.

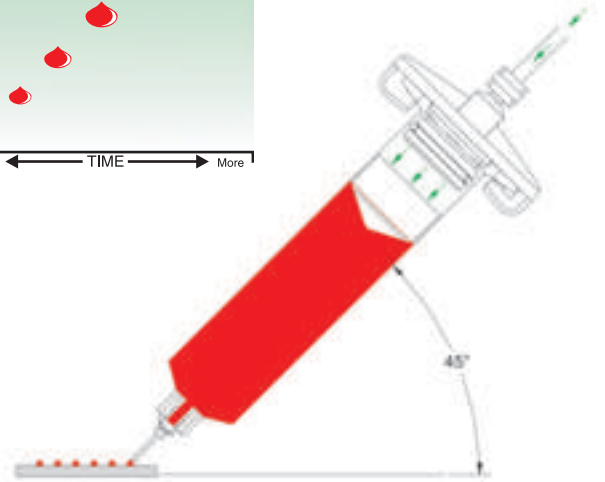

### Viscosity Chart

Material	Viscosity (Centipoise)
Water	1
Milk	3
Castor Oil	1000
Maple Syrup	5000
Honey	10000
Chocolate Syrup	25000
Ketchup	50000
Sour Cream	100000
Peanut Butter	250000
Shortening	1200000

### Shot Size Chart

Dot Diameter	Dot Volume	Dot Size (actual)
0.010" (0.25mm)	0.0000043 cc	.
0.020" (0.51mm)	0.00003 cc	.
0.030" (0.76mm)	0.0001 cc	.
0.040" (1.02mm)	0.0003 cc	.
0.050" (1.27mm)	0.0005 cc	.
0.060" (1.52mm)	0.0009 cc	.
0.070" (1.78mm)	0.0015 cc	.
0.080" (2.03mm)	0.0022 cc	.
0.090" (2.29mm)	0.0031 cc	.
0.100" (2.54mm)	0.0043 cc	.

# Valve Diagrams

**TS5620**  
Diaphragm Valve

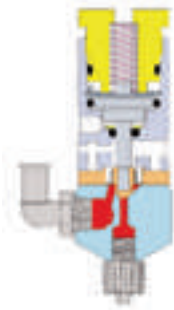

**TS5540**  
Spray Valve

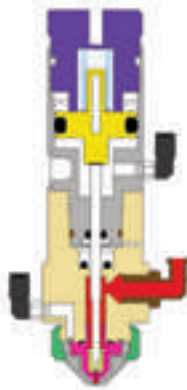

**TS5322**  
Mini Spool Valve

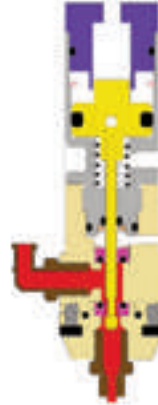

**TS5000DMP**  
Rotary Valve

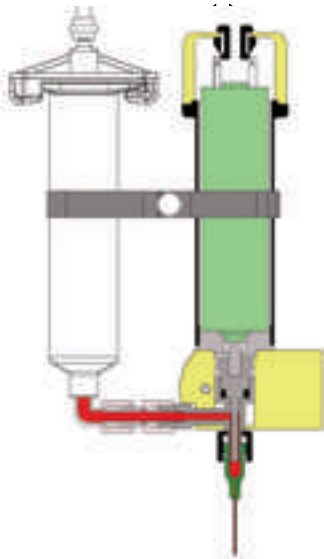

**TS5420**  
Needle Valve

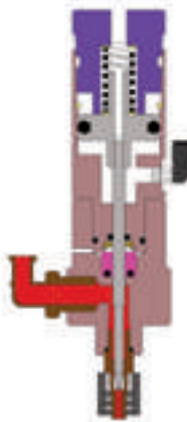

**TS5440**  
Microshot Needle Valve

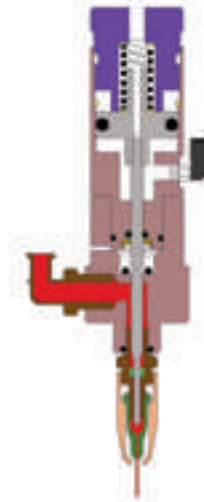

**TS941**  
High Pressure Spool Valve

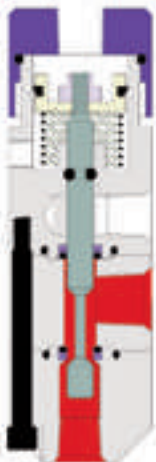

**TS7000**  
IMP Rotary Valve

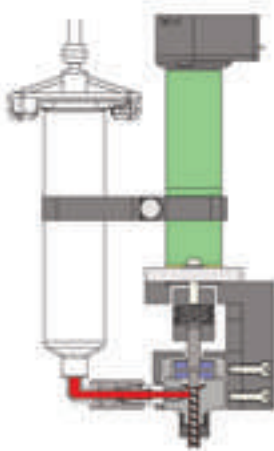

**TS1212**  
Pinch Tube Valve

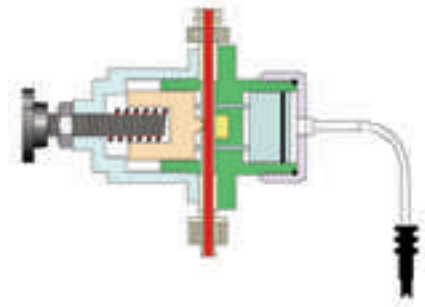



**OKInternational**

North America  
12151 Monarch Street • Garden Grove, California 92841 USA  
Tel: +1-714-799-9910 • Fax: +1-714-799-9533

[www.techconsystems.com](http://www.techconsystems.com)