

# QuantX<sup>™</sup>

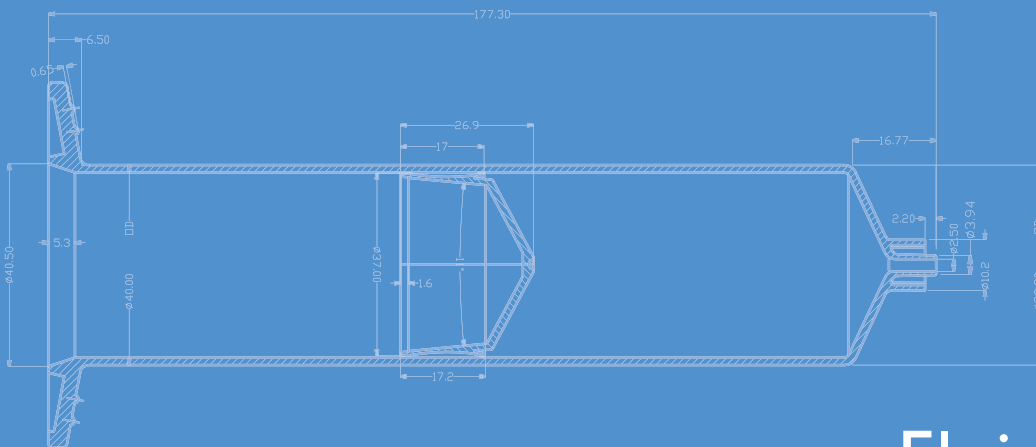

Fluid Management

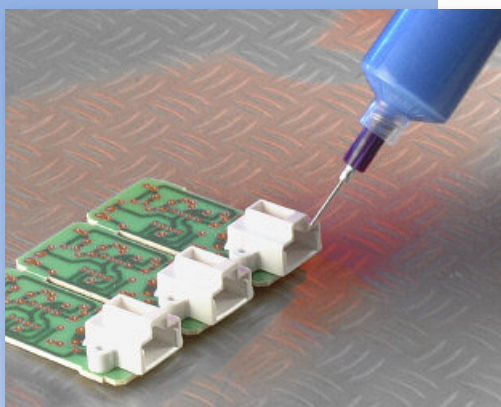
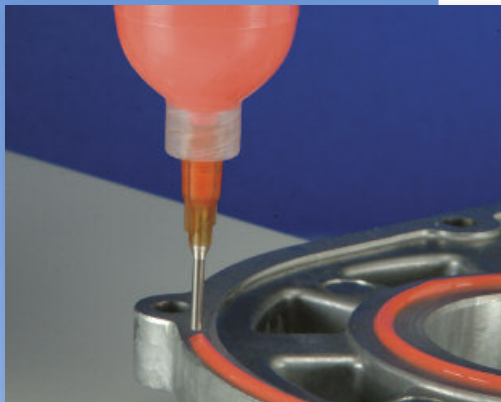

## 2 QuantX™ Fluid Management

### 3 QuantX™ - DCK500 Dispensing Component Kit

### 4 QuantX™ Barrels and Accessories

QuantX™ Syringe Barrels  
Evenpress™ Air Powered Pistons  
QuantX™ Syringe Barrel End Caps  
QuantX™ Syringe Barrel Tip Caps

### 5 QuantX™ Barrel Adapters and Parts

QuantX™ Syringe Barrel Adapters  
QuantX™ Adapter Replacement Parts

### 6-7 Standard Barrels and Accessories

Syringe Barrels and Pistons  
Syringe Barrel Adapters and Accessories  
Syringe Barrel Tip Caps  
Syringe Barrel End Caps

### 8 Manual Syringe, Plungers & Components

Luer Lock Manual Syringe Kits and Accessories  
Luer Slip Graduated Syringe Kits

### 9 Micron-S Precision Nozzles

Standard Bore  
Micro Bore

### 10-11 Blunt End Tips - Epoxy Sealed

Straight Cannula Blunt End Tips  
Angled Cannula Blunt End Tips

### 12 Blunt End Tips - Crimp Sealed

Straight Cannula Blunt End Tip Crimp Sealed  
Teflon Lined Straight Cannula

### 13 Tapered Tips

Tapered Smooth Flow Tips  
Color Coded UV Block Tapered Tips  
Black UV Block Tapered Tips

### 14 Flexible and Brush Dispensing Tips

Flexible Tips  
Brush Tips

### 15 Stainless Steel Dispensing Tips

Single and Multi Cannula all Stainless Steel Tips

### 16-17 Cartridges and Accessories

Cartridges, Plungers and Caps  
Metal Cartridge Retainers and Accessories  
Tip Adapters and Connecting Hoses

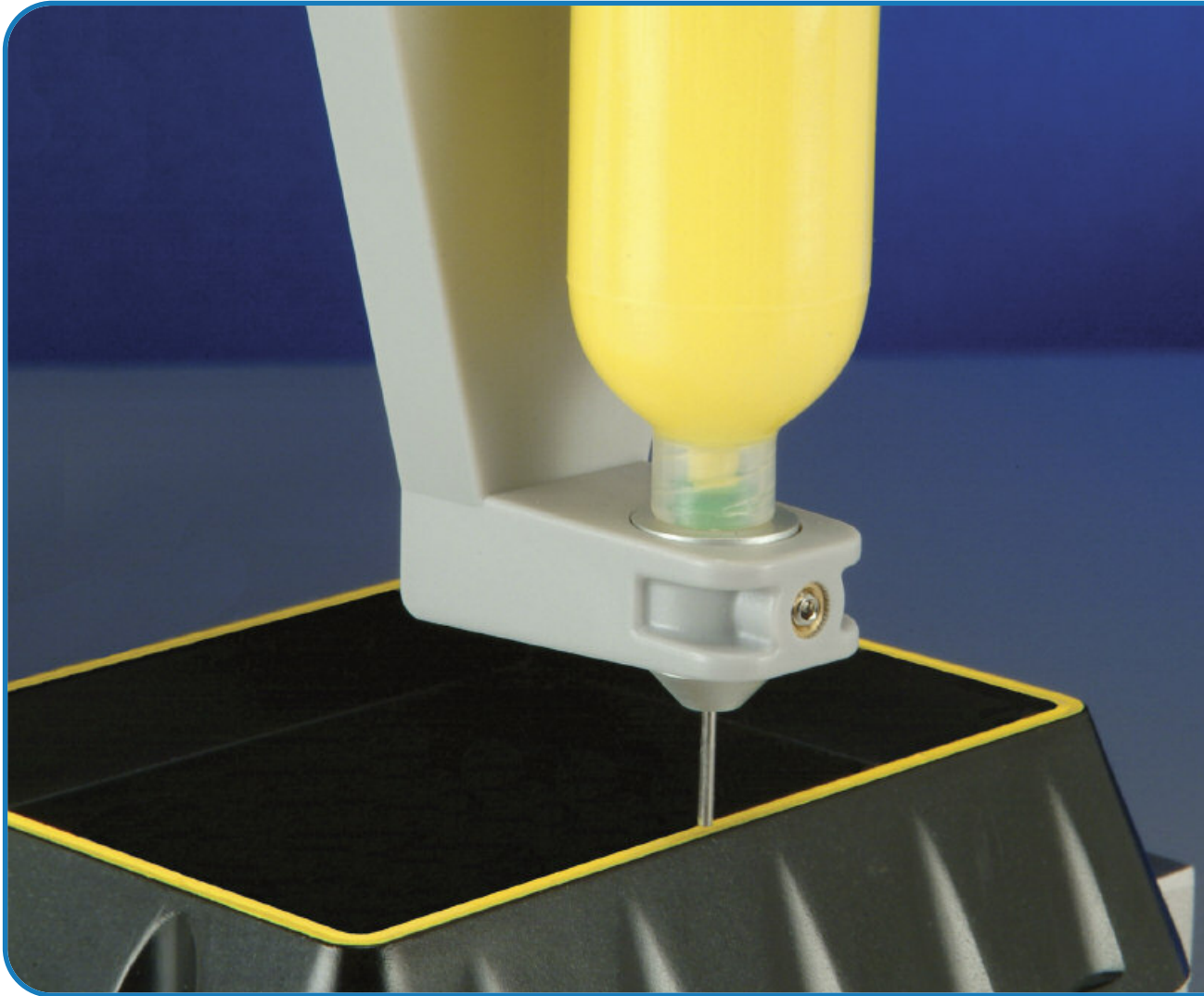

## **18-19 Dispensing Nozzles and Cartridge Guns**

Standard and Specialty Cartridge Nozzle  
Cartridge Tip Adapters  
Cartridge Dispensing Guns

## **20-21 Dispensing Bottles and Accessories**

Polyspense™ Dispensing Bottles  
Polyspense™ Glass Bottle and Dropper  
Eco™ Kit Squeeze Bottle  
Dipit™ Touch Pump and Brushes

## **22 Flow-Seal Pens and Bottles**

Plastic and Aluminum Flow-Seal Pens and Bottles  
Flow-Seal Replacement Nibs

## **23-25 Mixing Nozzles**

Nozzle Retaining Nuts and Luer Lock Adapters  
Rotary Static Nozzles  
Static Nozzles

# QuantX™

*A completely new dispensing experience.*

## QuantX™

...a fluid management system defined by its carefully designed and precisely engineered dispensing components. Together these components provide a superior industrial dispensing experience, resulting in reduced waste and greater accuracy.



# Dispensing Component Kit

QuantX™

## DCK500 - Dispensing Component Kit

The DCK500 Dispensing Component Kit includes a selection of QuantX™ syringe barrels, pistons and caps, a selection of popular tip types and sizes, together with a supply reference chart for new orders. The kit is contained in a rugged plastic case with a removable tray that increases the variety of components.

**Note:** A DCK500 is supplied free with most Fisnar dispensing controller models. These models will also include 3 x 30cc barrels 8001004 & 3 x 30cc pistons 8001009, 2 x 5cc barrels 8001002 & 2 x 5cc pistons 8001007, together with 1 x 30cc 8001017 and 1 x 5cc 8001015 syringe barrel adapter. The items are supplied with the dispenser controller and not in the DCK500 Component Kit.



<b>Tapered Tip</b> 25 Gauge ID: 0.010" 0.25mm <b>Red</b> P/N: 8001274 5 Pieces	<b>Tapered Tip</b> 22 Gauge ID: 0.016" 0.41mm <b>Blue</b> P/N: 8001273 5 Pieces	<b>Tapered Tip</b> 20 Gauge ID: 0.023" 0.58mm <b>Pink</b> P/N: 8001272 5 Pieces	<b>Tapered Tip</b> 18 Gauge ID: 0.033" 0.84mm <b>Green</b> P/N: 8001271 5 Pieces	<b>Tapered Tip</b> 16 Gauge ID: 0.047" 1.20mm <b>Grey</b> P/N: 8001270 5 Pieces	<b>Tapered Tip</b> 14 Gauge ID: 0.063" 1.60mm <b>Olive</b> P/N: 8001269 5 Pieces
<b>½" Needle Tip (12.7mm)</b> 30 Gauge ID: 0.006" 0.15mm <b>Lavender</b> P/N: 8001094 5 Pieces	<b>½" Needle Tip (12.7mm)</b> 27 Gauge ID: 0.008" 0.20mm <b>Clear</b> P/N: 8001093 5 Pieces	<b>½" Needle Tip (12.7mm)</b> 25 Gauge ID: 0.010" 0.25mm <b>Red</b> P/N: 8001092 5 Pieces	<b>½" Needle Tip (12.7mm)</b> 23 Gauge ID: 0.013" 0.33mm <b>Orange</b> P/N: 8001091 5 Pieces	<b>½" Needle Tip (12.7mm)</b> 22 Gauge ID: 0.016" 0.41mm <b>Blue</b> P/N: 8001090 5 Pieces	<b>½" Needle Tip (12.7mm)</b> 21 Gauge ID: 0.020" 0.51mm <b>Purple</b> P/N: 8001089 5 Pieces
<b>½" Needle Tip (12.7mm)</b> 20 Gauge ID: 0.024" 0.58mm <b>Pink</b> P/N: 8001088 5 Pieces	<b>½" Needle Tip (12.7mm)</b> 18 Gauge ID: 0.033" 0.84mm <b>Green</b> P/N: 8001087 5 Pieces	<b>½" Needle Tip (12.7mm)</b> 16 Gauge ID: 0.047" 1.20mm <b>Black</b> P/N: 8001086 5 Pieces	<b>½" Needle Tip (12.7mm)</b> 15 Gauge ID: 0.054" 1.37mm <b>Amber</b> P/N: 8001085 5 Pieces	<b>½" Needle Tip (12.7mm)</b> 14 Gauge ID: 0.063" 1.60mm <b>Olive</b> P/N: 8001084 5 Pieces	<b>LIFT</b>



### DCK500

The DCK500 Dispensing Component Kit is a convenient bench consumable storage and reference kit. A careful selection of the most typically used dispensing components are included, comprising:

Barrels, pistons, tips, end caps and tip caps.

This chart maps the location, type and quantity of the components.

Fisnar Inc.  
 15 Corporate Drive  
 Wayne, NJ 07470 - USA  
 Tel: 1(973) 646-5044  
 E-mail: info@fisnar.com  
 www.fisnar.com

<b>¼" Needle Tip (6.35mm)</b> 18 Gauge <b>Green</b> P/N: 8001075 2 Pieces	<b>1" Needle Tip (25.4mm)</b> 18 Gauge <b>Green</b> P/N: 8001097 2 Pieces	<b>1½" Needle Tip (38.1mm)</b> 18 Gauge <b>Green</b> P/N: 8001107 1 Piece	<b>½" Flexible Tip (12.7mm)</b> 18 Gauge <b>Green</b> P/N: 8001287 2 Pieces	<b>1½" Flexible Tip (38.1mm)</b> 18 Gauge <b>Green</b> P/N: 8001293 1 Piece	<b>Barrel Tip Cap</b> <b>Natural</b> P/N: 5601054 <b>Black</b> P/N: 5601058 3 Pieces	<table border="0"> <tr> <td><b>Barrel (Round)</b></td> <td><b>End Caps (Clip Style)</b></td> <td><b>Pistons (Smooth-Flow)</b></td> </tr> <tr> <td>Size: 3cc</td> <td>Size: 3cc</td> <td>Size: 3cc</td> </tr> <tr> <td><b>Natural</b></td> <td><b>Green</b></td> <td><b>Green</b></td> </tr> <tr> <td>P/N: 8001001</td> <td>P/N: 8001034</td> <td>P/N: 8001006</td> </tr> <tr> <td>Size: 5cc</td> <td>Size: 5cc</td> <td>Size: 5cc</td> </tr> <tr> <td><b>Natural</b></td> <td><b>Green</b></td> <td><b>Green</b></td> </tr> <tr> <td>P/N: 8001002</td> <td>P/N: 8001035</td> <td>P/N: 8001007</td> </tr> <tr> <td>Size: 10cc</td> <td>Size: 10cc</td> <td>Size: 10cc</td> </tr> <tr> <td><b>Natural</b></td> <td><b>Green</b></td> <td><b>Green</b></td> </tr> <tr> <td>P/N: 8001003</td> <td>P/N: 8001036</td> <td>P/N: 8001008</td> </tr> <tr> <td>1 Piece</td> <td>1 Piece</td> <td>1 Piece</td> </tr> </table>	<b>Barrel (Round)</b>	<b>End Caps (Clip Style)</b>	<b>Pistons (Smooth-Flow)</b>	Size: 3cc	Size: 3cc	Size: 3cc	<b>Natural</b>	<b>Green</b>	<b>Green</b>	P/N: 8001001	P/N: 8001034	P/N: 8001006	Size: 5cc	Size: 5cc	Size: 5cc	<b>Natural</b>	<b>Green</b>	<b>Green</b>	P/N: 8001002	P/N: 8001035	P/N: 8001007	Size: 10cc	Size: 10cc	Size: 10cc	<b>Natural</b>	<b>Green</b>	<b>Green</b>	P/N: 8001003	P/N: 8001036	P/N: 8001008	1 Piece	1 Piece	1 Piece
<b>Barrel (Round)</b>	<b>End Caps (Clip Style)</b>	<b>Pistons (Smooth-Flow)</b>																																					
Size: 3cc	Size: 3cc	Size: 3cc																																					
<b>Natural</b>	<b>Green</b>	<b>Green</b>																																					
P/N: 8001001	P/N: 8001034	P/N: 8001006																																					
Size: 5cc	Size: 5cc	Size: 5cc																																					
<b>Natural</b>	<b>Green</b>	<b>Green</b>																																					
P/N: 8001002	P/N: 8001035	P/N: 8001007																																					
Size: 10cc	Size: 10cc	Size: 10cc																																					
<b>Natural</b>	<b>Green</b>	<b>Green</b>																																					
P/N: 8001003	P/N: 8001036	P/N: 8001008																																					
1 Piece	1 Piece	1 Piece																																					
<b>45° Needle Tip (½ inch, 12.7mm)</b> 18 Gauge <b>Green</b> P/N: 8001158 2 Pieces	<b>90° Needle Tip (½ inch, 12.7mm)</b> 18 Gauge <b>Green</b> P/N: 8001168 2 Pieces	<b>UV Safe Tapered Tip</b> 16 Gauge <b>Black</b> P/N: 8001259 2 Pieces	<b>Teflon Lined Tip (1.37", 34.8mm)</b> ID: 0.023" 0.58mm <b>Grey</b> P/N: 8001254 2 Pieces	<b>Brush Tip</b> Bristle Type: Soft <b>Tangerine</b> P/N: 5601309 1 Piece	<b>Flat Tip Cap</b> <b>Green</b> P/N: 8001038 3 Pieces																																		
22 Gauge <b>Blue</b> P/N: 8001161 2 Pieces	22 Gauge <b>Blue</b> P/N: 8001171 2 Pieces	18 Gauge <b>Black</b> P/N: 8001261 2 Pieces	ID: 0.006" 0.15mm <b>Pink</b> P/N: 8001255 2 Pieces	Bristle Type: Hard <b>Tangerine</b> P/N: 5601310 1 Piece																																			

© Fisnar Inc. 4/2012

# Barrels & Accessories



## QuantX™ Fluid Management

QuantX™ syringe barrels feature a highly accurate manufacturing process that combines minimal resistance and ultra parallel uniformity over the length of the syringe barrel. These features make QuantX™ the first choice for packaging high-value fluids and for accurate dot and line dispensing.

Syringe barrels are manufactured from premium grade, silicone-free, polypropylene. Natural for non UV materials, amber for UV protection up to 520nm visible light, and opaque black for maximum light protection.

## QuantX™ Syringe Barrels

Size	Pk Qty.	Base	Natural	Amber	Black	I.D. (inch)	O.D. (inch)	Length (inch)
3cc	50	Round	8001001	8001040	8001045	0.379	0.453	2.941
5cc	40	Round	8001002	8001041	8001046	0.500	0.567	2.756
10cc	30	Round	8001003	8001042	8001047	0.622	0.733	3.567
30cc	20	Round	8001004	8001043	8001048	0.891	1.000	4.634
55cc	15	Round	8001005	8001044	8001049	0.891	1.020	6.898

## QuantX™ Air Powered - Evenpress™ Polyethylene Pistons

Evenpress™ pistons apply pressure evenly across the fluid and trap fluid and fumes in the syringe barrel. They also help to prevent tunneling in higher viscosity fluids. Pistons should not be used with Cyanoacrylates due to potential stalling caused by blooming of the material. Amber and black syringe barrels are used with UV fluids.

Smooth-Flow



Flat-Wall



## Evenpress™ Piston Selection

Evenpress™ smooth-flow, low-friction pistons are recommended for most dispensing applications. The double-wipe design prevents air entrapment and material waste by wiping the syringe barrel wall clean.

Evenpress™ flat-wall pistons are recommended for reducing potential stringing and bouncing when dispensing high-viscosity fluids.

Size	Pk Qty.	Base	Smooth-Flow Green	Flat-Wall Blue
3cc	50	Round	8001006	8001010
5cc	40	Round	8001007	8001011
10cc	30	Round	8001008	8001012
30/55cc	20	Round	8001009	8001013

## QuantX™ Syringe Barrel End Caps

Green polyethylene clip style quick-twist end caps ensure an air tight seal and secure the neck opening of the syringe barrel when not in use or in storage.

Size	Pk Qty.	End Cap Clip
3cc	10	8001034
5cc	10	8001035
10cc	10	8001036
30/55cc	10	8001037



## QuantX™ Syringe Barrel Flat-Base Tip Caps

Size	Pk Qty.	Tip Cap	Color
Fits all	25	8001038	Green
Fits all	100	8001038-BULK	Green



# Adapter & Accessories

QuantX™

## QuantX™ Syringe Barrel Adapters With 1/8" (3.175mm) Hose

QuantX™ syringe barrel adapter assemblies provide a convenient quick connect to the controller from the syringe barrel. They are available in two hose lengths with optional micron filter-traps.

Size	Pk Qty.	3ft (91cm)	6ft (152cm)	3ft (91cm) Includes Filter
Hose 1/8" (3.175mm) OD green adapter head, includes safety clip				
3cc	1	8001014	8001018	8001050
5cc	1	8001015	8001019	8001051
10cc	1	8001016	8001020	8001052
30/55cc	1	8001017	8001021	8001053



## QuantX™ Adapter Replacement Parts



### QuantX™ Adapter Head With O-Ring No Hose

Size	Pk Qty.	1/8" 3.175mm OD (green)
3cc	1	8001026
5cc	1	8001027
10cc	1	8001028
30/55cc	1	8001029

## QuantX™ Syringe Barrel Adapter O-Rings

Replacement O-rings for syringe barrel adapters in Buna N.

Size	Pk Qty.	Buna N
3cc	10	8001030
5cc	10	8001031
10cc	10	8001032
30/55cc	10	8001033



## QuantX™ Tubing, Safety Clips, Fluid Filter Traps

Filter traps and safety clips are indispensable accessories for low-viscosity fluids.

Item	Pk Qty.	Part #
Tube 1/8"	x 1ft	5606030
Safety clip 1/8"	1	5606034
Fluid filter trap 1/8"	1	5606037

# 500 Series Standard Barrels and Accessories

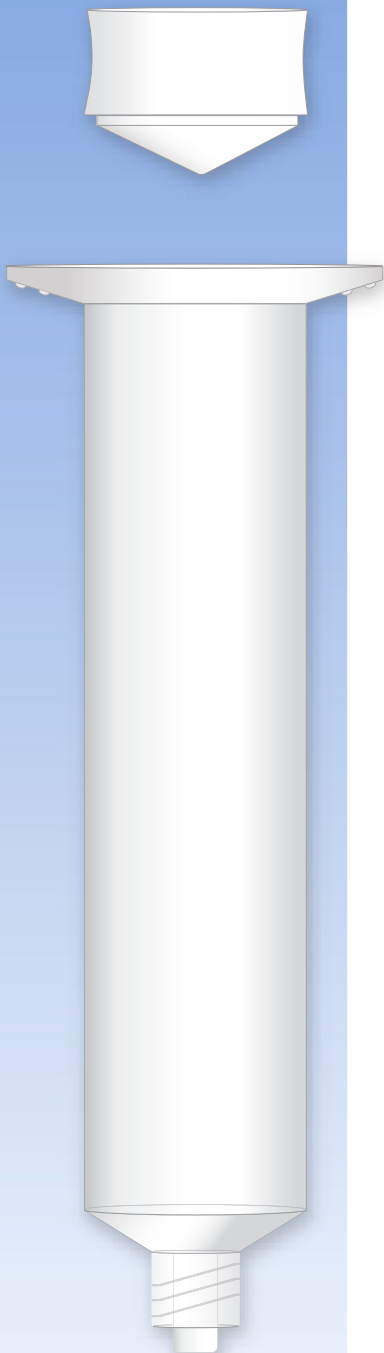

## 500 Series Dispensing Components

An established, long-standing product design, which continues to provide an excellent choice when value is an important consideration. The 500 series has minimal resistance over the length of the syringe barrel.

### 500 Series Syringe Barrels - Silicone-Free

Available in high-grade, silicone-free polypropylene for non UV materials, amber for UV protection up to 520nm visible light, and opaque black for maximum light protection.

Size	Pk Qty.	Base	Natural	Amber	Black	I.D. (inch)	O.D. (inch)	Length (inch)
3cc	10	Bevel	5601000		5601012	0.374	0.451	2.830
5cc	10	Bevel	5601001		5601013	0.493	0.573	2.616
10cc	10	Round	5601002	5601008	5601014	0.634	0.739	3.478
10cc	10	Bevel	5601003		5601015	0.634	0.739	3.478
30cc	10	Bevel	5601004	5601009	5601016	0.885	1.001	4.527
30cc	10	Round	5601005	5601010		0.885	1.001	4.527
55cc	10	Round	5601006	5601011	5601017	0.885	1.021	6.846
55cc	10	Bevel	5601007			0.885	1.021	6.846

\*Part numbers listed above are for packs of 10, also sold in bulk.

### 500 Series Air Powered Polyethylene Pistons

Pistons serve two purposes. They spread pressure evenly across the fluid and trap the fluid in the syringe. They also prevent tunneling in higher-viscosity fluids. Pistons should not be used with Cyanoacrylates due to potential stalling caused by blooming of the material.

Size	Pk Qty.	Syringe Base	White PE	Black PE
3cc	50	Bevel	5601018	
5cc	40	Bevel	5601019	
10cc	30	Round	5601020	
10cc	30	Bevel	5601021	5601024
30cc	20	Bevel	5601465	5601462
30/55cc	20	Round	5601022	
55cc	20	Bevel	5601023	5601025

### 500 Series Industrial Syringe Barrel & Piston Kits

A combined packaged kit of 100 syringes and 100 PE pistons for optimum storage and fast retrieval. White wiper pistons included.

Minimum Quantity 100, sold in multiples of 100.

Size	Pk Qty.	Natural	Amber	Black
3cc	100	5601311		5601319
5cc	100	5601312		5601320
10cc	100	5601313	5601316*	5601321
30cc	100	5601314	5601317	5601322
55cc	100	5601315	5601318*	

\*Round bottom barrel

### 500 Series Syringe Barrel Pistons - Rubber, Lubricated

Soft black neoprene pistons are used to prevent tunneling in high-viscosity fluids. Care should be taken to ensure the piston is suitable for the dispensing application.

Size	Pk Qty.	Piston
3cc	10	5601066
5cc	10	5601067
10cc	10	5601068
30/55cc	10	5601069





## 500 Series Syringe Barrel Adapters

Syringe barrel adapter assemblies connect a syringe to a time/pressure controller. They provide a convenient, quick connect at the controller and the syringe barrel and are available in two tube lengths and O.D sizes.

Size	Pk Qty.	3ft (91cm)	6ft (152cm)	3ft (91cm) Includes Filter
<b>Hose 1/8" (3.175mm) OD</b> <i>blue adapter head, includes safety clip</i>				
3cc	1	5601034	5601038	5601490
5cc	1	5601035	5601039	5601491
10cc	1	5601036	5601040	5601492
30cc	1	5601468	5601469	5601493
55cc	1	5601037	5601041	5601494
<b>Hose 1/4" (6.35mm) OD</b> <i>black adapter head, includes safety clip</i>				
5cc	1	5601027	5601031	5601451
10cc	1	5601028	5601032	5601452
30cc	1	5601466	5601467	5601471
55cc	1	5601029	5601033	5601453

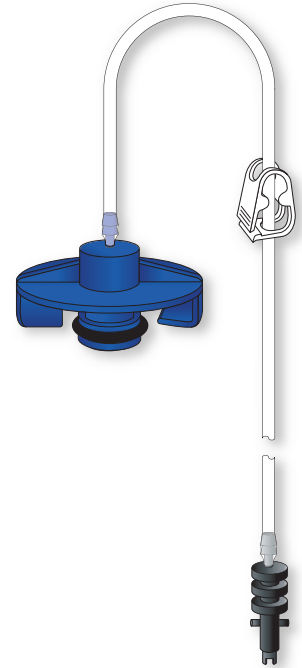

## 500 Series Adapter Fitting With O-Ring, No Hose

Size	Pk Qty.	1/8" 3.175mm OD (blue)	1/4" 6.35mm OD (black)
3cc	1	5601478	
5cc	1	5601479	5601455
10cc	1	5601480	5601456
30cc	1	5601481	5601460
55cc	1	5601482	5601457

## 500 Series Syringe Barrel Adapter O-Rings

Replacement O-rings for syringe barrel adapters in standard Buna N and solvent-resistant Viton.



Size	Pk Qty.	Buna N	Viton (Solvents)
3cc	10	5601042	5601046
5cc	10	5601043	5601047
10cc	10	5601044	5601048
30cc	10	5401017	5401024
55cc	10	5601045	5601049

## 500 Series Syringe Barrel End Caps

Red polyethylene end caps secure the neck opening of the syringe barrel when not in use or in storage. Blue clip-style, quick-twist end caps ensure air-tight seal.

Size	Pk Qty.	End Cap Bung	End Cap Clip
3cc	10	5601050	5601070
5cc	10	5601051	5601071
10cc	10	5601052	5601072
30/55cc	10	5601053	5601073

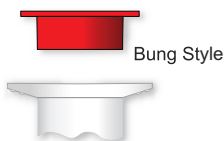

## 500 Series Tubing, Safety Clips, Clamps, Fluid Filter Traps and Quick-Connect

Filter traps and safety clips are indispensable accessories for low-viscosity fluids.

Item	Pk Qty.	Part #
Tube 1/8"	x 1ft	5606030
Safety clip 1/8"	1	5606034
Male connect 1/8"	1	5606035
Tube 1/4"	x 1ft	5601060
Safety clip 1/4"	1	5601061
Tube clamp 1/4"	1	5601062
Tube clamp 1/4"	1	5601063 Tool needed
Male connect 1/4"	1	5601064
Fluid filter trap 1/4"	1	5601065 Includes clamps

## 500 Series Syringe Barrel Tip Caps

Size	Pk Qty.	Tip Cap	Color
Fits all	10	5601054	Natural
Fits all	100	5601055	Natural
Bulk	100+	5601427	Natural
Fits all	10	5601056	White
Fits all	100	5601057	White
Bulk	100+	5601472	White
Fits all	10	5601058	Black
Fits all	100	5601059	Black
Bulk	100+	5601428	Black



## 500 Series Syringe Barrel Flat-Base Tip Caps

Size	Pk Qty.	Tip Cap	Color
Fits all	50	5401010	Blue
Fits all	100	5401011	Blue



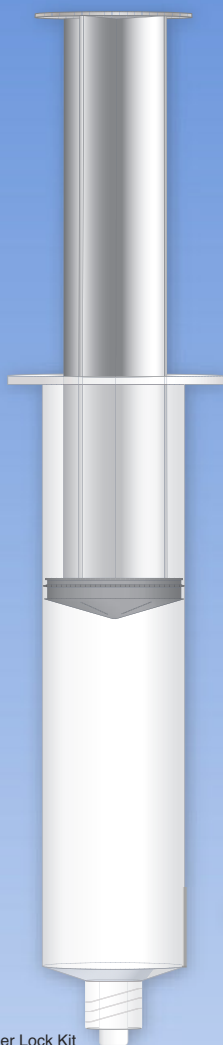

Luer Lock Kit

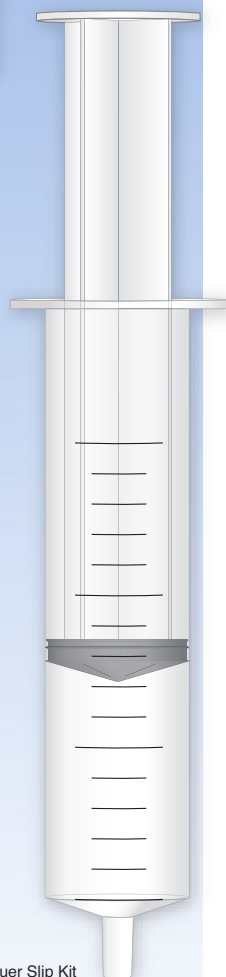

Graduated Luer Slip Kit

## Manual Syringes

A range of disposable components that together form a system to manually dispense fluids ranging from low to high viscosities.

### Graduated Syringe Barrel Kits Luer Slip

Polypropylene molded barrels with Luer Slip style connectors including stopper and plunger.

**Minimum 1 kit**

Size	Pk Qty.	Clear
3cc	10	5401006
5cc	10	5401007
10cc	10	5401008
30cc	10	5401009
60cc	10	5401012

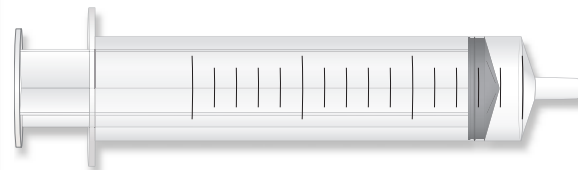

### Syringe Kits Luer Lock

Includes Luer Lock barrel, plunger and lubricated stopper.

**Bulk - Minimum 100 kits**

Size	Pk Qty.	Clear
3cc	1	5401032
6cc	1	5401033
10cc	1	5401034
35cc	1	5401035
60cc	1	5401036



\*Unlubricated available upon request

### Syringe Barrels Luer Lock

Polypropylene molded syringe barrels with Luer lock connectors. Available in natural color.

Size	Pk Qty.	Clear
3cc	10	5401000
6cc	10	5401001
10cc	10	5401002
35cc	10	5401004
60cc	10	5401005

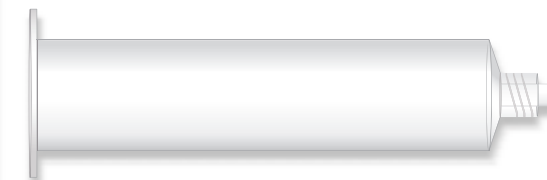

### Manual stoppers for all styles, Lubricated

Size	Pk Qty.	Black rubber
3cc	10	5401021
6cc	10	5401022
10cc	10	5401023
35cc	10	5401025
60cc	10	5401026



\*Unlubricated available upon request

### Plungers for all styles

Size	Pk Qty.	Part Number
3cc	10	5401014
6cc	10	5401015
10cc	10	5401016
35cc	10	5401018
60cc	10	5401019



### Syringe caps fits all styles

Pk Qty.	Color	Part Number
100	Natural	5601055
100	Black	5601059



## Micron-S Precision Nozzles

Dispense nozzles for high accuracy micro-dot dispensing. Micron-S nozzles have a Luer lock thread and can be used with any dispensing syringe, valve or pump.

Super low resistance molecular fluid flow. Significant cost savings over machined nozzles without sacrificing placement precision or deposition accuracy.

## Thin Rigid Thin Wall Conical Design

A primary design feature of this unique Luer lock dispensing nozzle is the stream-line conical fluid path which delivers substantially higher fluid flow rates and lower dispense pump back pressures, resulting in improved dispensing accuracy and component life.

The design also employs very thin rigid walls offering a larger I.D. fluid path which enables the use of smaller O.D. nozzles without sacrificing dispense rates.

Additionally, the thin walls further enhance the accuracy and definition of dots, lines, or special patterns while at the same time dramatically reducing fluid stringing or tailing tendencies.



## Features

- Micro precision dispense dots and lines to 50 microns
- Conical tapered convergent duct (optimized flow path)
- Repeatable precision
- Thin rigid metal construction
- Color coded hubs
- Secure Luer lock connection
- Precision solder paste deposition
- Precision close die tolerance underfill
- Medical precision
- MEMS
- Semiconductor packaging
- Automated micro-dispensing applications
- Re-usable hub option

## Key Benefits

- Precision machined accuracy
- Improved accuracy on robotic applications
- Dispense higher viscosities with lower pressures
- Resist clogging, improved fluid break off, no stringing
- A solution for proximity challenges
- Luer adaptation

## Micron-S Precision Standard Bore

Color	Gauge	I.D. (inch)	I.D. (mm)	O.D. (inch)	O.D. (mm)	Part Number (Qty. 8 pcs)	Part Number Apticoat 450F
Pink	18	0.041	1.041	0.049	1.254	5901001	5901012
Tan	19	0.034	0.864	0.042	1.067	5901002	5901013
Green	20	0.027	0.686	0.035	0.889	5901003	5901014
Light Blue	21	0.024	0.609	0.032	0.813	5901004	5901015
Purple	23	0.022	0.564	0.025	0.635	5901005	5901016
White	25	0.017	0.437	0.020	0.508	5901006	
Red	27	0.013	0.335	0.016	0.406	5901007	
Black	30	0.009	0.233	0.012	0.305	5901008	

## Micron-S Micro Bore

Color	Exit	I.D. (inch)	I.D. (mm)	O.D. (inch)	O.D. (mm)	Part Number (Qty. 5 pcs)
Blue	150µm	0.006	0.16	0.010	0.24	5901009
Orange	100µm	0.004	0.11	0.008	0.20	5901010
Yellow	50µm	0.002	0.06	0.006	0.16	5901011

## Nozzle Materials

18-30 Gauge

Material: (UNS C51000) Phosphor Bronze  
Plating: Electroless Nickel, Entecoat, None

23-30 Gauge; 150µm, 100µm, 50µm

Material: (UNS C73500) Electroless Nickel Silver  
Plating: Electroless Nickel, Entecoat, None

**NEW** - Entecoat coating greatly reduces wicking affect when using aqueous fluids and significantly improves performance of anaerobic as well as UV cure materials. Material highly loaded with PTFE and is inert. Entecoat is a replacement for stainless steel. Minimum size 50 gauge. Call for Part Number and pricing.

\*Custom materials can be quoted on request.

## Product Packaging

- Polypropylene Luer hubs
- Standard Bore packaged in quantity of 8 pcs
- Micro Bore packaged in quantity of 8 pcs
- Nozzles are color coded
- Rated to 50°C (122°F)

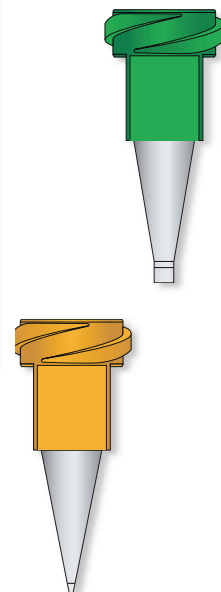



### Straight Cannula Blunt End Tips - Epoxy Sealed

Construction - stainless steel, straight cannula, epoxy sealed to a double helix Luer lock polypropylene hub. Polished burr-free finish for smooth fluid dispensing.

Pack Quantity 50 pcs.

Color	Gauge	I.D. (inch)	I.D. (mm)	1/4" (6.35mm)	1/2" (12.7mm)	1" (25.4mm)	1.50" (38.1mm)
Olive	14	0.063	1.60		8001084	8001095	8001105
Amber	15	0.054	1.37		8001085	8001096	8001106
Black	16	0.047	1.20	8001074	8001086	8006031	
Green	18	0.033	0.84	8001075	8001087	8001097	8001107
Pink	20	0.024	0.60	8001076	8001088	8001098	8001108
Purple	21	0.020	0.51	8001077	8001089	8001099	8001109
Blue	22	0.016	0.41	8001078	8001090	8001100	8001110
Orange	23	0.013	0.33	8001079	8001091	8001101	8001111
Red	25	0.010	0.25	8001080	8001092	8001102	8001112
Beige	26	0.009	0.23		8001463		
Clear	27	0.008	0.20	8001081	8001093	8001103	8001113
Lavender	30	0.006	0.15	8001082	8001094	8001104	8001114
Yellow	32	0.004	0.10	8001083			

### Bulk Packaged - In Multiples of 100 pcs.

Color	Gauge	I.D. (inch)	I.D. (mm)	1/4" (6.35mm)	1/2" (12.7mm)	1" (25.4mm)	1.50" (38.1mm)
Olive	14	0.063	1.60		5601125	5601136	5601146
Amber	15	0.054	1.37		5601126	5601137	5601147
Black	16	0.047	1.20	5601115	5601127	5606032	
Green	18	0.033	0.84	5601116	5601128	5601138	5601148
Pink	20	0.024	0.60	5601117	5601129	5601139	5601149
Purple	21	0.020	0.51	5601118	5601130	5601140	5601150
Blue	22	0.016	0.41	5601119	5601131	5601141	5601151
Orange	23	0.013	0.33	5601120	5601132	5601142	5601152
Red	25	0.010	0.25	5601121	5601133	5601143	5601153
Beige	26	0.009	0.23		5601464		
Clear	27	0.008	0.20	5601122	5601134	5601144	5601154
Lavender	30	0.006	0.15	5601123	5601135	5601145	5601155
Yellow	32	0.004	0.10	5601124			

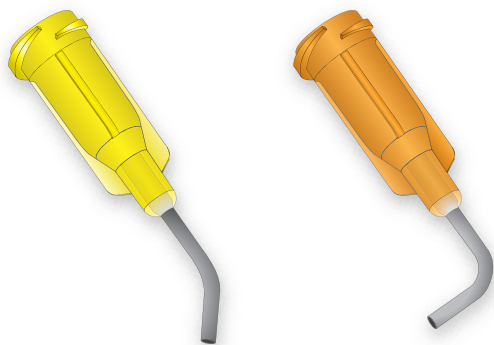

## Angled Cannula Blunt End Tips - Epoxy Sealed

Construction - stainless steel, angled cannula epoxy sealed to a double helix Luer lock polypropylene hub. Polished burr-free finish for smooth fluid dispensing.

1/2" Length - Pack Quantity 50 pcs.

Color	Gauge	I.D. (inch)	I.D. (mm)	45°		90°	
				1/2" (12.7mm)	1/2" (12.7mm)	1/2" (12.7mm)	1/2" (12.7mm)
Olive	14	0.063	1.60	8001156	8001166	8001156	8001166
Amber	15	0.054	1.37	8001157	8001167	8001157	8001167
Green	18	0.033	0.84	8001158	8001168	8001158	8001168
Pink	20	0.024	0.60	8001159	8001169	8001159	8001169
Purple	21	0.020	0.51	8001160	8001170	8001160	8001170
Blue	22	0.016	0.41	8001161	8001171	8001161	8001171
Orange	23	0.013	0.33	8001162	8001172	8001162	8001172
Red	25	0.010	0.25	8001163	8001173	8001163	8001173
Clear	27	0.008	0.20	8001164	8001174	8001164	8001174
Lavender	30	0.006	0.15	8001165	8001175	8001165	8001175

## Bulk Packaged - In Multiples of 100 pcs.

Color	Gauge	I.D. (inch)	I.D. (mm)	45°		90°	
				1/2" (12.7mm)	1/2" (12.7mm)	1/2" (12.7mm)	1/2" (12.7mm)
Olive	14	0.063	1.60	5601176	5601186	5601176	5601186
Amber	15	0.054	1.37	5601177	5601187	5601177	5601187
Green	18	0.033	0.84	5601178	5601188	5601178	5601188
Pink	20	0.024	0.60	5601179	5601189	5601179	5601189
Purple	21	0.020	0.51	5601180	5601190	5601180	5601190
Blue	22	0.016	0.41	5601181	5601191	5601181	5601191
Orange	23	0.013	0.33	5601182	5601192	5601182	5601192
Red	25	0.010	0.25	5601183	5601193	5601183	5601193
Clear	27	0.008	0.20	5601184	5601194	5601184	5601194
Lavender	30	0.006	0.15	5601185	5601195	5601185	5601195

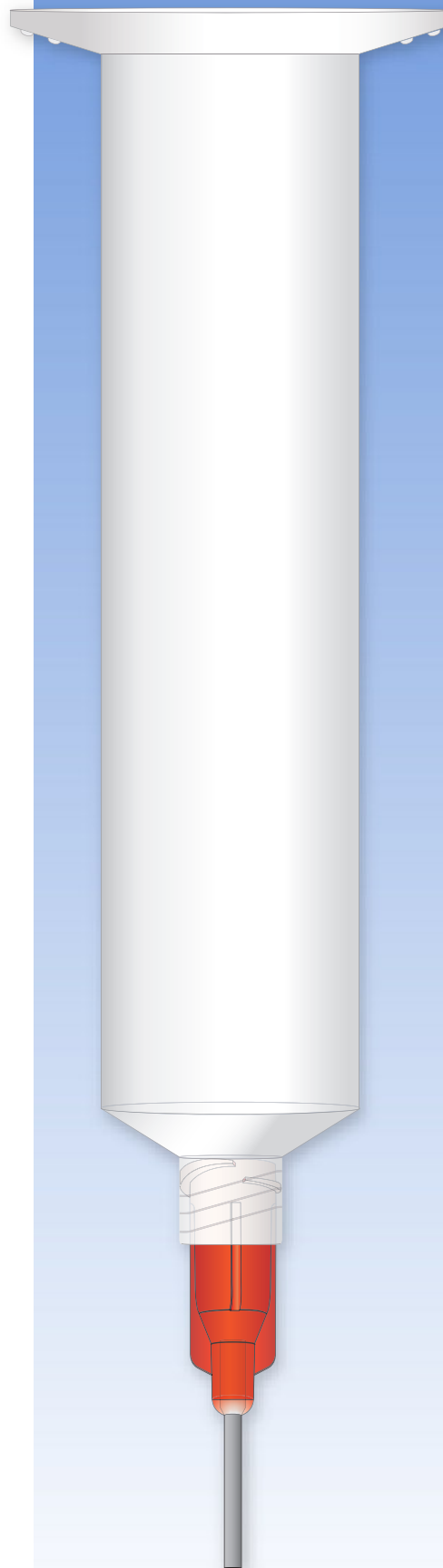

# 500 Series

## Dispensing Tips Straight - Crimp Seal

### Straight Cannula Blunt End Tips - Crimp Sealed

Construction - stainless steel, straight cannula, crimp sealed to a polypropylene hub with "ear-type" Luer lock fastening. Polished burr-free finish for smooth fluid dispensing.

#### 1/2" Length - Qty 50 pcs and Bulk - In Multiples of 100 pcs.

Color	Gauge	I.D. (inch)	I.D. (mm)	1/2" (12.7mm) Qty. 50 pcs	1/2" (12.7mm) Bulk - Min. Qty. 100 pcs
Aluminum	14	0.063	1.60	8001196	5601217
Dark Green	14	0.063	1.60	8001197	5601218
Aluminum	15	0.054	1.37	8001198	5601219
Green	18	0.033	0.84	8001199	5601220
Brown	19	0.027	0.69	8001200	5601221
Pink	20	0.023	0.58	8001201	5601222
Purple	21	0.020	0.51	8001202	5601223
Blue	22	0.016	0.41	8001203	5601224
Orange	23	0.013	0.33	8001204	5601225
Red	25	0.010	0.25	8001205	5601226
Beige	26	0.009	0.22	8001206	5601227
Lavender	30	0.006	0.15	8001208	5601229

#### 1" Length - Qty 50 pcs and Bulk - In Multiples of 100 pcs.

Color	Gauge	I.D. (inch)	I.D. (mm)	1" (25.4mm) Qty. 50 pcs	1" (25.4mm) Bulk - Min. Qty. 100 pcs
Aluminum	14	0.063	1.60	8001209	5601230
Aluminum	15	0.054	1.37	8001210	5601231
Pink	18	0.033	0.84	8001211	5601232
Brown	19	0.027	0.69	8001212	5601233
Yellow	20	0.023	0.58	8001213	5601234
Green	21	0.020	0.51	8001214	5601235
Black	22	0.016	0.41	8001215	5601236
Light Blue	23	0.013	0.33	8001216	5601237

### Straight Cannula Teflon Lined

Stainless steel, straight cannula with a Teflon insert lining that projects approximately 1/8" (3.18mm) from the cannula. Teflon tips are ideal for very low-viscosity fluids, solvents and Cyanoacrylates. 1.37" (34.8mm) length.

Sold in packages of 50 and bulk in multiples of 100 pcs.

Color	Crimp I.D. (inch)	Crimp I.D. (mm)	Teflon Lined Qty. 50 pcs	Teflon Lined Bulk - Min. Qty. 100 pcs
Grey	0.023	0.58	8001254	5601256
Pink	0.006	0.15	8001255	5601257

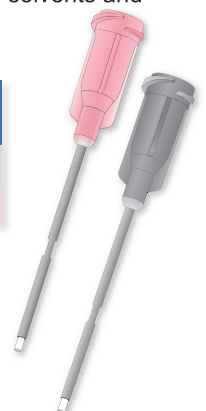

## Tapered Smooth Flow Tips for High-Viscosity Fluids

Construction - tapered smooth-flow tips with molded Luer lock polypropylene hub. Uniform length and flash free for consistent fluid dispensing.

Pack Qty. 50 pcs and Bulk in Multiples of 100 pcs.

Color	Gauge	I.D. (inch)	I.D. (mm)	Standard Luer lock (Qty. 50 pcs)	Luer lock Double Tapered (Qty. 50 pcs)	Luer lock Economy (Qty. 50 pcs)	Luer lock Economy Bulk - Min. Qty. 100 pcs
Olive	14	0.063	1.60			8001269	5601275
Orange	14	0.063	1.60		8001263		
Grey	16	0.047	1.20	8001258	8001264	8001270	5601276
Black	16	0.047	1.20	8001259			
Green	18	0.033	0.84	8001260	8001265	8001271	5601277
Black	18	0.033	0.84	8001261			
Pink	20	0.023	0.58		8001266	8001272	5601278
Black	20	0.023	0.58	8001262			
Blue	22	0.016	0.41		8001267	8001273	5601279
Red	24	0.014	0.37		8001268		
Red	25	0.010	0.25			8001274	5601280

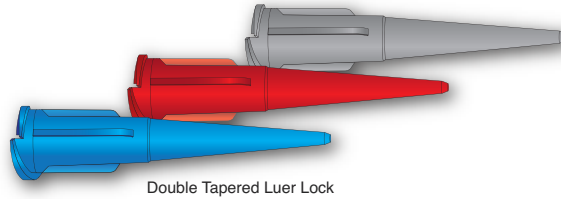
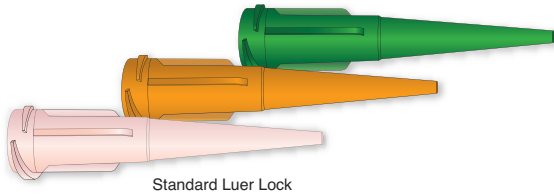

## Color Coded Tapered UV Block Plastic Tips

Color-coded tapered tips molded in high density polyethylene with a UV light block additive. These tips include a double helix luer lock hub. The tapered tip prevents blockage and improves the flow of high-viscosity fluids.

Bulk - in Multiples of 100 pcs.

Color	Gauge	1.25" (31.75mm) Bulk - Min. Qty. 100 pcs
Olive	14	5701253
Grey	16	5701254
Green	18	5701255
Pink	20	5701256
Blue	22	5701257
Red	25	5701258
Clear	27	5701271



## Black UV Tapered Smooth-Flow Tips for High-Viscosity UV Fluids

Bulk - in Multiples of 100 pcs.

Gauge	I.D. (inch)	I.D. (mm)	UV Safe Tapered Bulk - Min. Qty. 100 pcs
16	0.047	1.20	5601281
18	0.033	0.84	5601282
20	0.023	0.58	5601283
22	0.016	0.41	5601284



# 500 Series Flexible & Brush Dispensing Tips

## Flexible Tips

Polypropylene color-coded tips for dispensing in hard-to-reach areas. Ends can be cut to remove any curing or customized to length. Suitable for Cyanoacrylates.

Pack Qty. 50 pcs. and Bulk - in Multiples of 100 pcs.

Color	Gauge	I.D. (inch)	I.D. (mm)	1/2" (12.7mm) Qty. 25 pcs	1.5" (38.1mm) Qty. 25 pcs	1/2" (12.7mm) Bulk - Min. Qty. 100 pcs	1.5" (38.1mm) Bulk - Min. Qty. 100 pcs
Olive	14	0.063	1.60	8001285	8001291	5601297	5601303
Amber	15	0.054	1.37	8001286	8001292	5601298	5601304
Green	18	0.033	0.84	8001287	8001293	5601299	5601305
Pink	20	0.023	0.58	8001288	8001294	5601300	5601306
Blue	22	0.016	0.41	8001289	8001295	5601301	5601307
Red	25	0.010	0.25	8001290	8001296	5601302	5601308

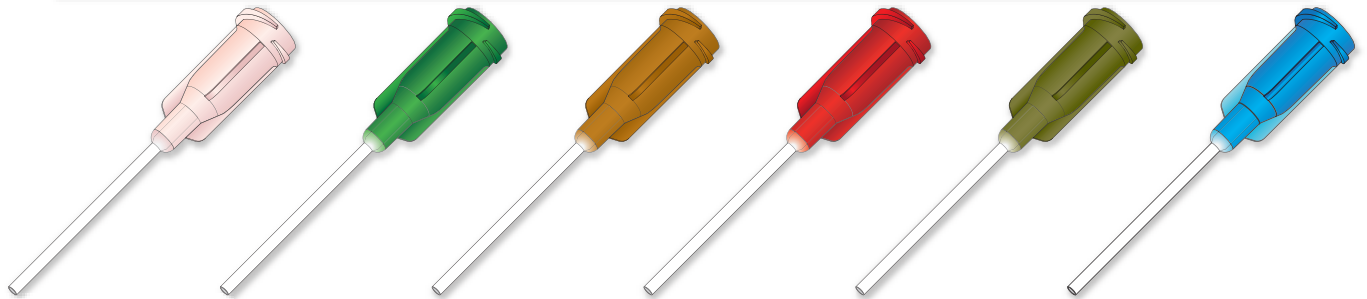

## Dispensing Brush Tips

Fluid pass-through dispensing brush tips for spreading applications with adhesives and other materials. Red sable used for soft brush and Nylon for hard.

Gauge	Soft Bristle (Qty. 1)	Hard Bristle (Qty. 1)
16	5701265	5701268
18	5701266	5701269
22	5701267	5701270



## Brush Tips

Brush dispensing tips are available in hard and soft versions.

Bristle Type	Color	Brush Tip (Qty. 1)
Soft	Tangerine	5601309
Hard	Tangerine	5601310

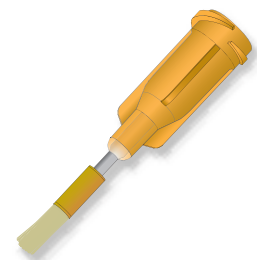



## Dispensing Tips All Stainless Steel

Stainless steel precision tips available in one, two, three or four cannula combinations for fine deposition.

### Single Cannula Stainless Steel Tips

Gauge	I.D. (mm)	O.D. (mm)	Length 13mm (Qty. 12 pcs)	Length 15mm (Qty. 12 pcs)
13	2.00	2.40		5601238
14	1.50	2.00		5601239
15	1.40	1.80		5601240
16	1.20	1.60		5601241
17	1.00	1.40		5601242
18	0.80	1.20		5601243
19	0.65	1.00		5601244
20	0.60	0.90		5601245
21	0.50	0.80		5601246
22	0.40	0.70	5601248	5601247
23	0.30	0.60		5601249
24	0.28	0.55		5601250
25	0.25	0.50		5601251
26	0.25	0.45		5601252
27	0.20	0.40		5601253

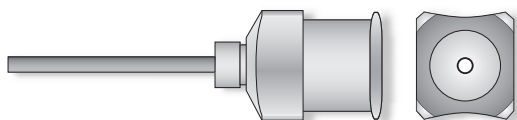

### Twin Cannula Stainless Steel Tips

Gauge	I.D. (mm)	O.D. (mm)	Length 20mm (Qty. 1)
16	1.20	1.60	5601323
17	1.00	1.40	5601324
18	0.80	1.20	5601325
19	0.65	1.00	5601326
20	0.60	0.90	5601327
21	0.50	0.80	5601328
22	0.40	0.70	5601329
23	0.30	0.60	5601330
24	0.28	0.55	5601331
26	0.25	0.45	5601332
27	0.20	0.40	5601333

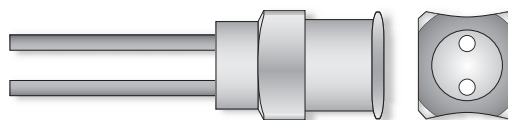

### Triple Cannula Stainless Steel Tips

Gauge	I.D. (mm)	O.D. (mm)	Length 20mm (Qty. 1)
18	0.80	1.20	5601334
19	0.65	1.00	5601335
20	0.60	0.90	5601336
21	0.50	0.80	5601337
22	0.40	0.70	5601338
23	0.30	0.60	5601339
24	0.28	0.55	5601340
25	0.25	0.50	5601341
26	0.25	0.45	5601342
27	0.20	0.40	5601343

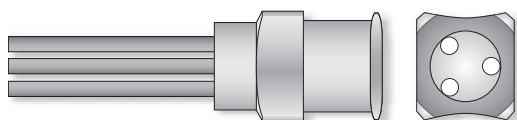

### Quad Cannula Stainless Steel Tips

Gauge	I.D. (mm)	O.D. (mm)	Length 20mm (Qty. 1)
18	0.80	1.20	5601344
19	0.65	1.00	5601345
20	0.60	0.90	5601346
21	0.50	0.80	5601347
22	0.40	0.70	5601348
23	0.30	0.60	5601349
24	0.28	0.55	5601350
25	0.25	0.50	5601351
26	0.25	0.45	5601352
27	0.20	0.40	5601353

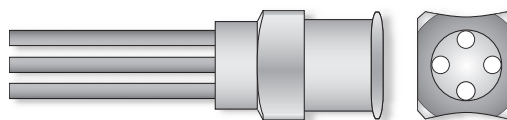

## Cartridges & Accessories

High quality disposable plastic cartridges and nozzles provide a clean, efficient and low-cost method to meet all types of production requirements. Plungers with a wiper leading edge clean each cartridge thoroughly. Caps and plugs for both ends of the cartridge are available, making the system ideal for prepackaged materials as well as pre-mixed and frozen product handling.

### Cartridges

Cartridges are available in 2.5, 6, 8, 12 and 20 ounce as well as 1/10 gallon capacities. Each size can be used with hand held or bench mounted air powered dispensing tools or manual dispensing tools. Cartridges are molded in either standard or low density Polyethylene.

Capacity	Length (inch)	Length (mm)	Diameter (inch)	Diameter (mm)	Natural LDPE (Qty. 10 pcs)	Natural HDPE (Qty. 10 pcs)	Black HDPE (UV Protect) (Qty. 10 pcs)
2.5 oz. (74ml)	4.00	101.60	1.59	40.40	5601358	5601364	5601370
6 oz. (177ml)	7.11	180.60	1.59	40.40	5601359	5601365	5601371
8 oz. (237ml)	8.92	226.60	1.59	40.40	5601360	5601366	5601372
12 oz. (355ml)	12.34	313.40	1.59	40.40	5601361	5601367	5601373
1/10 Gal (310ml)	8.99	228.30	1.85	47.00	5601362	5601368	5601374
20 oz. (591ml)	10.03	254.80	2.57	65.30		5601369	5601375

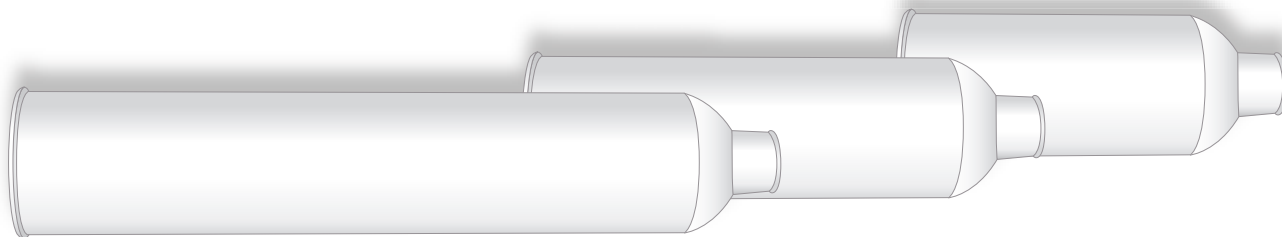

### Plungers

Plungers assist in the prevention of tunneling with viscose fluids and provide even pressure.

Part Number (Qty. 10 pcs)	Color	Description / Material
5601354	Blue	2.5,6,8,12 oz. wiper, LDPE
5601355	White	1/10 gallon wiper, LDPE
5601356	Natural	20 oz. wiper, LDPE
5601439	Black	2.5,6,8,12 oz. UV blocking wiper, LDPE
5601440	Black	1/10 gallon UV blocking wiper, LDPE

LD = low density, PE = polyethylene

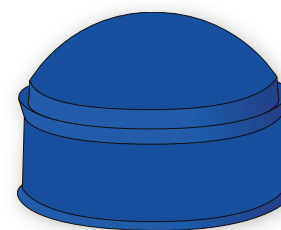

### Cartridge Caps

Top flange caps seal the wide brim of the cartridge and bottom caps seal the dispensing or tip end of the cartridge.

Part Number (Qty. 10 pcs)	Color	Description / Material
5601383	Red	2.5,6,8,12 oz. flange cap, LDPE
5601384	Red	1/10 gallon flange cap, LDPE
5601385	Red	20 oz. flange cap, LDPE
5601386	Red	Threaded tri seal tip cap, PE
5601387	Red	Snap on tri seal tip cap, PE
5601388	Red	Threaded tip cap, PE
5601389	Red	Push on red tip cap, PE
5601441	Black	Threaded tip cap UV blocking, LDPE

LD = low density, PE = polyethylene



## Metal Cartridge Retainers

Heavy gauge drawn metal retainers to accommodate all cartridges. Requires retainer cap.

Part Number (Qty. 1)	Cartridge Size / Description
5601379*	2.5 oz. (74ml)
5601380*	6 oz. (177ml)
5601381*	8 oz. (237ml)
5601382*	12 oz. (355ml)
5601417	20 oz. (591ml) requires 5601418
5601418	Adapter - required for 20 oz retainer
5605008*	1/10 Gal. (310ml) retainer with cap

\*Slotted cartridge retainer

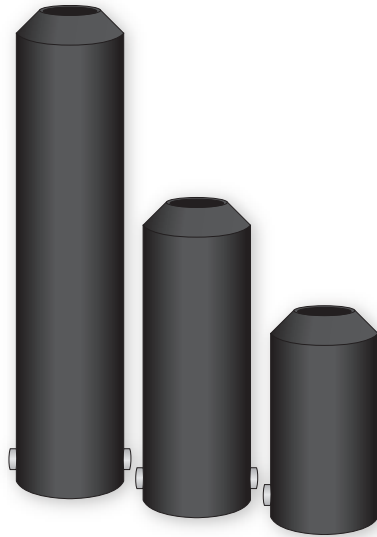

## Tip Adapters

Part Number (Qty. 3 pcs)	Description (includes PTFE tape)
5601390	Tip adapter white polypropylene
5601449	Tip adapter black polypropylene
5601420	Tip adapter metal

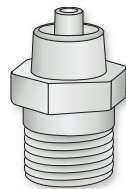

Cartridges  
& Valves

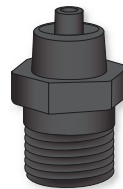

Cartridges

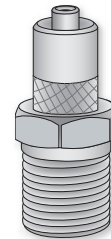

Cartridges  
& Valves

## Retainer Cap

Retainer caps provide a secure lock of the cartridge and metal retainer. Supplied with a female quick connect and sealing ring. One size fits all. Except 5601417, 5601418 & 5605008. Maximum Pressure 103psi (7bar)

Part Number (Qty. 1)	Description
5601376	Retainer cap with seal ring
5601377	Retainer cap with regulator gauge
5601378	Sealing ring only
5601429	Retainer Cap for 5601418



## Connecting Hose

A 5ft (152cm) hose to connect a retainer cap and dispenser. Includes a male quick connect each end.

Part Number (Qty. 1)	Description
5601357	Connecting hose 5ft. (152cm)

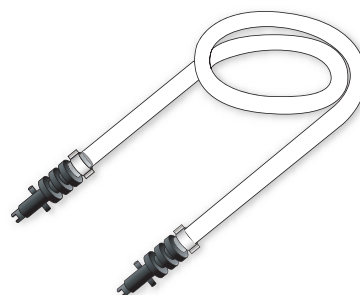

# Dispensing Nozzles and Tip Adapters

## Disposable Nozzles & Tip Adapters

Nozzles and dispensing tip adapters provide a wide range of application capabilities. Standard nozzles may be cut back to increase orifice size. Tip adapters have standard 1/4" NPT male threads to fit all Fisnar cartridges or equivalent and standard male Luer lock threads on opposite side to fit all Luer lock dispensing tips.

### Standard Nozzles

Standard nozzles are precision molded from Natural Polyethylene and have 1/4" NPT male threads to fit all Fisnar cartridges or equivalent. These nozzles can be ordered with 30, 45, 80 and 90 degree bends, however minimum order, lead time and pricing considerations apply.

Length (inches)	Length (mm)	Orifice Size (inch)	Orifice Size (mm)	Material (mm)	Part Number (Qty. 10 pcs)
2	63.5	1/16	1.59	HDPE	5601391
2	63.5	1/8	3.18	HDPE	5601392
2	63.5	1/8	3.18	LDPE	5601393
4	101.6	1/16	1.59	HDPE	5601394
4	101.6	1/16	1.59	LDPE	5601395
4	101.6	1/8	3.18	HDPE	5601396
4	101.6	1/32	0.79	HDPE	5601397
4	101.6	1/32	0.79	LDPE	5601398
4	101.6	3/32	2.38	HDPE	5601399
5.875	149.2	1/16	1.59	HDPE	5601400
6	152.4	1/16	1.59	HDPE	5601401
8	203.2	1/8	3.18	HDPE	5601402

LD = low density, HD = High Density, PE = polyethylene

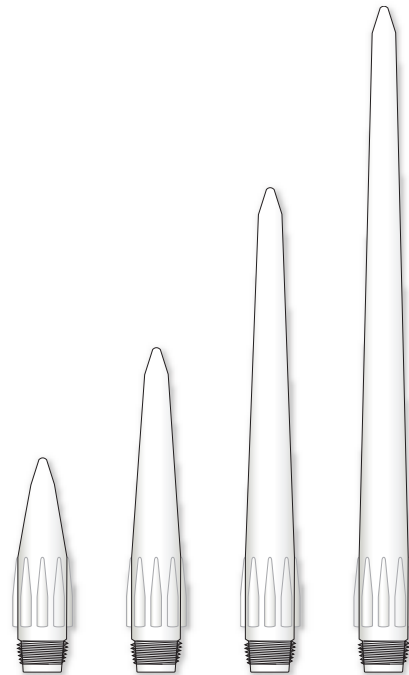

### Specialty Nozzles

Specialty nozzles are precision molded from Polyethylene and have 1/4" NPT male threads to fit all Fisnar cartridges or equivalent. Available in various thickness and widths to meet a special application.

Nozzle Style	Length (inches)	Length (mm)	Orifice Size (inch)	Orifice Size (mm)	Part Number (Qty. 5 pcs)
Spreader	4	101.6	1/2 x 1/16	12.7 x 1.59	5601404
45° Spreader	4	101.6	1/2 x 1/16	12.7 x 1.59	5601405
Spreader	4.5	114.3	3/4 x 1/8	19.05 x 3.18	5601406
Spreader	4.4	111.76	1 x 1/8	25.4 x 3.18	5601407
Spreader	4	101.6	1 3/4 x 1/8	44.45 x 3.18	5601408
Fillet	4	101.6	3/8 x 1/8	9.53 x 3.18	5601409
Fillet, Left Step	4	101.6	3/8 x 1/8	9.53 x 3.18	5601410
Extra Reach	10	254	1/8	3.18	5601411
Spreader	5	127	3/8 x 3/64	9.52 x 1.19	5601412
Brush	4.87	123.7	1 3/4	44.45	5601413
Spreader	3 5/16	84.14	3/4 x 1/8	19.05 x 3.17	5601414
Spatula	3.62	92.07	3/4 x 1/8	19.05 x 3.17	5601415
Extension	6.37	161.8			5601416

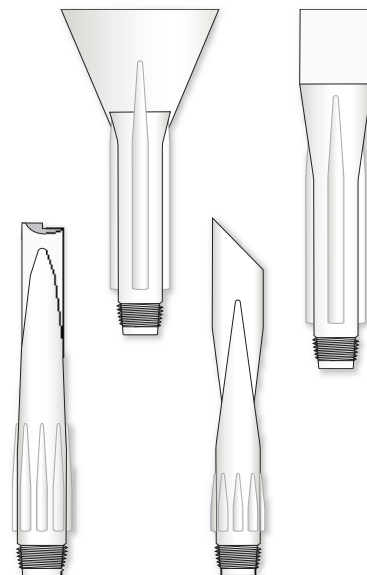

### Tip Adapters

Part Number (Qty. 3 pcs)	Description (includes PTFE tape)
5601390	Tip adapter white polypropylene
5601449	Tip adapter black polypropylene
5601420	Tip adapter metal

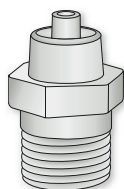

Cartridges  
& Valves

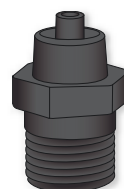

Cartridges

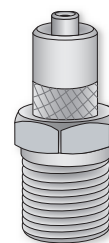

Cartridges  
& Valves

## F350N Pneumatic Cartridge Gun Dispenser

A pneumatic ergonomic gun designed for precision dispensing of sealants, potting compounds, adhesives and silicones packaged in disposable plastic cartridges. Engineered and constructed for rigorous production environments, the F350N is also quiet in operation.

The F350N series is available with retainers to suit 2.5oz (59cc), 6oz (156cc), 8oz (214cc) and 12oz (310cc) cartridges. Retainers are affixed to the gun via a quick-connect, secure bayonet lock feature, allowing easy cartridge replacement.

A selection of different length air hoses is available and ordered separately.



### Models - Complete pneumatic gun (less hose)

Model #	Description / Size
F351N	Gun only - No retainer
F352N	Gun and retainer 59cc (2.5oz)
F353N	Gun and retainer 156cc (6oz)
F354N	Gun and retainer 214cc (8oz)
F355N	Gun and retainer 310cc (12oz)
Hose Assemblies* (1/4" NPT)	
2890500	1.5m (5ft)
2890100	2.9m (10ft)
2890150	4.4m (15ft)
2890200	5.9m (20ft)
2890250	7.3m (25ft)
2890300	8.9m (30ft)

\*Hoses Assemblies are supplied with a female 1/4" universal fitting

### Specifications

Cartridge sizes:	2.5oz (59cc), 6oz (156cc), 8oz (214cc), 12oz (310cc)
Cycle:	Trigger actuated manually timed
Shot volume:	Red regulator wheel
Regulated air input:	(Regulator not included)
Air pressure:	0-100psi (0 - 6 bar)
Weight:	Gun only - 1.1lbs (0.505kg)

## F950N Manual Cartridge Gun Dispenser

A manual ergonomic gun designed for accurate dispensing of sealants, potting compounds, adhesives and silicones that are packaged in disposable plastic cartridges.

The F950N is excellent for applying sealants, adhesives and other materials in remote areas where an air supply is unavailable, including field repair applications. The smooth-stroke handle is made of an engineered plastic for tough, durable, long-term use. The dispense rod is released from pressure after every stroke to help eliminate material drooling.

The F950N series is available with retainers to suit 2.5 oz (59cc), 6oz (156cc), 8oz (214cc) and 12oz (310cc) cartridges. Retainers are affixed to the gun via a quick connect secure bayonet lock feature allowing easy cartridge replacement



### Models - Complete manual gun

Model #	Description / Size
F951N	Gun and retainer 59cc (2.5oz)
F952N	Gun and retainer 156cc (6oz)
F953N	Gun and retainer 214cc (8oz)
F954N	Gun and retainer 310cc (12oz)

### Specifications

Cartridge sizes:	2.5oz (59cc), 6oz (156cc), 8oz (214cc), 12oz (310cc)
Cycle:	Trigger actuated manually timed
Weight:	Gun only - 2.5lbs



## PolySpense™

### Low Density PE Dispensing Bottles with Needle Tips

LDPE squeeze type *PolySpense* needle-bottle kits, feature a unique Luer lock cap that accommodates all Fisnar blunt end or plastic taper tip needles. Available in 3/4, 1, 2 and 4 oz sizes (1 oz = 29.57ml), *PolySpense* needle-bottle kits are ideal for dispensing alcohols, cleaning agents, flux, Cyanoacrylates, adhesives, solder mask, and other materials.

Needle-Bottle kits include: LDPE bottle, cap-seal with Luer lock thread and 5 pieces of 27 gauge 1.0 inch (25.4mm) long needles. (For a selection of needles turn to page 10)

Size	Qty.	Description	Detail	Part Number
3/4 oz	5	Needle-bottle kit	Oval 15-415	5606000
1 oz	5	Needle-bottle kit	Round 20-410	5606001
2 oz	5	Needle-bottle kit	Round 20-410	5606002
4 oz	5	Needle-bottle kit	Oval 20-410	5606003
Parts List				
3/4 oz	10	Luer-lock cap	Black 15-415	5606004
1, 2 & 4 oz	10	Luer-lock cap	Blue 20-410	5606005
3/4 oz	10	Squeeze bottle only	15-415	5606006
1 oz	10	Squeeze bottle only	20-410	5606007
2 oz	10	Squeeze bottle only	20-410	5606008
4 oz	10	Squeeze bottle only	20-410	5606009



## PolySpense™ - Low Density PE Dispensing Bottles

A range of impact resistant LDPE *PolySpense* bottles for dispensing liquids. LDPE provides a good moisture barrier against leaching or ingress and has a high temperature threshold. *PolySpense* bottles are an excellent choice for dispensing low viscosity fluids controlled by gentle squeezing.

Bottles can be used with a Spout-Cap and stored with a PE lined Cap.

Size	Qty.	Type	Thread	Detail	Part Number
1/2oz	10	LDPE bottle only	15-415	Natural	5606010
1 oz	10	LDPE bottle only	18-410	Natural	5606011
2 oz	10	LDPE bottle only	18-410	Natural	5606012
4 oz	10	LDPE bottle only	24-410	Natural	5606013
8 oz	10	LDPE bottle only	24-410	Natural	5606014
1/2 oz	10	Spout-cap seal	15-415	Red tip 0.030mm	5606015
1 & 2 oz	10	Spout-cap seal	18-410	Red tip 0.030mm	5606016
4 & 8 oz	10	Spout-cap seal	24-410	Red tip 0.030mm	5606017
2 oz	10	PE lined cap	18-410	Black phenol	5606018
4 & 8 oz	10	PE lined cap	24-410	Black phenol	5606019



## PolySpense™ - Glass Bottle & Dropper

A 2 oz (59.14ml) Boston Round flat bottom glass bottle.

Bottles can be used with a cap-seal threaded dropper.

Size	Qty.	Type	Thread	Detail	Part Number
2 oz	10	Glass bottle only	20-400	Clear glass	5606020
2 oz	10	Dropper	20-400	Black	5606021



### Eco™ Kit

The new Eco™ Kit is an excellent low cost squeeze bottle kit that includes a press-fit Dropper Plug, which can be safely inserted into the LDPE bottle secured by a ported Seal Cap (included). This unique feature allows the Dropper Plug to safely pass through the port in the Seal Cap. The Dropper Plug can then be diagonally nipped or pierced by a needle to obtain the right orifice for dispensing.

The Eco™ Kit is available in 1 oz (29.57ml) and 2 oz (59.14ml) options and designed as an economical disposable dispensing bottle when used with Cyanoacrylates or other non cleanable adhesives, solvents or agents.

Size	Qty.	Type	Description	Part Number
1 oz	5	Dispense kit	Eco™ kit 1 oz	5606022
2 oz	5	Dispense kit	Eco™ kit 2 oz	5606023
Parts List				
1 oz	10	LDPE	Bottle 20-410	5606007
2 oz	10	LDPE	Bottle 20-410	5606028
1 & 2 oz	10	Press fit	Dropper plug	5606024
1 & 2 oz	10	Phenol white	Seal-Cap	5606025

### PolySpense™ - High Density PE Dipit™ Touch-Pump Bottles

Dipit™ Touch-pump bottles provide an economic, clean and safe method of conveniently presenting a small reservoir of solvent, cleaner or alcohol. Fluid-ready for dipping a brush or wipe for an assembly, production or laboratory purpose. Ideal for PCB soldering operations and clean rooms. Prevents wasteful evaporation & contamination. Stainless steel lid and pump components for long life.

Size	Type	Description	Part Number
100ml 3.4oz	Dipit™	Touch-pump	5606026
200ml 7.0oz	Dipit™	Touch-pump	5606027



### Dipit™ Brush

These comfortable, form fitting Dipit™ brushes include, corrosion resistant, static dissipative zinc plated steel and clean room Delrin styles. Brush materials are Nylon and Natural Bristle. Handles hold fibers in place by 5 tons of mechanical clamping and without any adhesives that could leach and contaminate surface areas.

Description	Part Number
Dipit brush Delrin 1/4" nylon soft	5701272
Dipit brush zinc/steel 3/8" bristle	5701273
Dipit brush dual head 3/16" - 1/4" hard	5701274



### Flow-Seal

Flow-seal environmental pens and bottles channel controlled amounts of no-clean flux, rma, solvents, lubricants, masking and water-based liquids. Flow-seal products prevent evaporation of material and conform to current regulations for controlling substances capable of evaporation hazard. A unique dispensing valve prevents flooding and spattering, releasing material in controlled amounts to the nib (tip).



### Assembly

The pen or bottle is in two parts (cap and reservoir) and is easily assembled. The reservoir should be filled with material to within 0.75" (19mm) of the top; this air chamber allows for the valve cap to be pressed securely in position. Priming is achieved by depressing the nib while the pen is vertical.



### Flow-Seal Pens and Bottles

Part Number (Qty. 1)	Description
FV-0100	Flow-seal pen clear
FV-0200	Flow-seal pen esd safe, aluminum
FV-0300	Flow-seal bottle 2 oz. clear (59.14ml)
FV-0400	Flow-seal bottle 2 oz. esd safe, aluminum
FV-0500	Flow-seal bottle 4 oz. clear (118.28ml)

Flow-Seal products are supplied with nib 381-8425-AC

### Flow-Seal Nibs

Part Number (Qty. 10 pcs)	Description
381-8425-AC	Nib acrylic chisel
381-8425-AB	Nib acrylic bullet
381-8425-AP	Nib acrylic point
381-8425-PC	Nib polyester chisel



## Static-Mixers 0.657" (16.7mm) yellow and 0.625" (15.9mm) blue

A complete line of static-mixing nozzles for metering and mixing equipment is featured on pages 24 & 25. Static-mixing nozzles are available in two inside-diameter sizes of bell-mouth:

0.657" (16.7mm) 167 (yellow)

0.625" (15.9mm) 159 (blue)

The bell-mouth is the material entry end of the nozzle and the part that fits over the machine exit manifold. Static-mixing elements inside the body of the nozzle are manufactured from high grade polyacetal to withstand the higher pressures of metering and mixing machines; static-mixer housings are polypropylene.

Luer-lock static-mixers are also available for fine bead applications using luer-lock tips; note part numbers with an "LL" suffix.

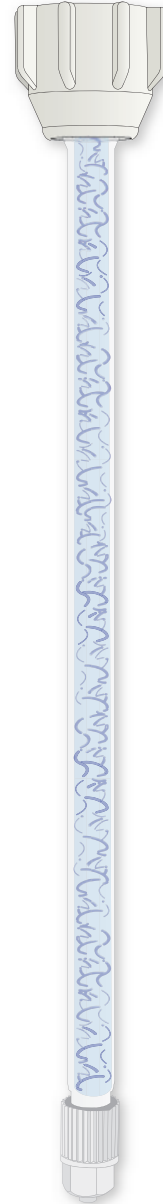

## Nozzle Retaining Nuts

Part Number	Pk Qty.	Description
UM08-PA	10	Nut beige for I.D. 5-8mm
UM10-PA	10	Nut beige for I.D. 10mm
UM13-PA	10	Nut beige for I.D. 13mm



## Luer-lock Adapters

Part Number	Pk Qty.	Color	Mixer Type
LA05-00	10	White	5mm
LA06-08	10	Grey	6 & 8mm
LA10-00	10	Black	10mm



## Rotary-Static Nozzles Green

Part Number	Pk Qty.	Length (inches)	Length (mm)	Inside Diam. (inch)	Inside Diam. (mm)	Outside Diam. (inch)	Outside Diam. (mm)	Number of Elements
MR06-12	10	4.39	111.5	0.250	6.35	0.394	10.00	12
MR08-12	10	5.12	130.0	0.315	8.00	0.475	12.00	12
MR10-12	10	6.10	115.0	0.394	10.00	0.551	14.00	12
MR13-12	10	7.76	197.0	0.512	13.00	0.661	17.00	12



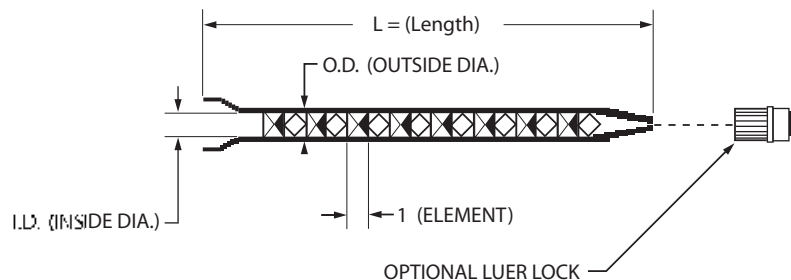

### MS Yellow Series Static-Mixers 0.657" (16.7mm)

The part numbers reflect the bell-mouth, I.D. and the number of elements. Example: 1670524 = a bell-mouth of 16.7mm, an I.D. of 5mm, and 24 mixing elements. 1670524LL is the same item but fitted with a luer lock adapter. Sold in packages of 10.

Part Number	Length (inches)	Length (mm)	Inside Diam. (Inch)	Inside Diam. (mm)	Outside Diam. (Inch)	Outside Diam. (mm)	Number of Elements	Content Volume (ml)
1670524	5.870	149	0.197	5.00	0.315	8.00	24	2.3
1670524LL	5.870	149	0.197	5.00	0.315	8.00	24	2.3
1670532	7.400	188	0.197	5.00	0.315	8.00	32	2.8
1670532LL	7.400	188	0.197	5.00	0.315	8.00	32	2.8
1670624	7.320	186	0.250	6.35	0.394	10.00	24	4.2
1670624LL	7.320	186	0.250	6.35	0.394	10.00	24	4.2
1670632	9.252	235	0.250	6.35	0.394	10.00	32	6.6
1670632LL	9.252	235	0.250	6.35	0.394	10.00	32	6.6
1670648	13.150	334	0.250	6.35	0.413	10.50	48	10.0
1670648LL	13.150	334	0.250	6.35	0.413	10.50	48	10.0
1670656	14.882	378	0.250	6.35	0.413	10.50	56	11.0
1670656LL	14.882	378	0.250	6.35	0.413	10.50	56	11.0
1670824	8.780	223	0.315	8.00	0.472	12.00	24	8.5
1670824LL	8.780	223	0.315	8.00	0.472	12.00	24	8.5
1670832	11.300	287	0.315	8.00	0.472	12.00	32	11.5
1670832LL	11.300	287	0.315	8.00	0.472	12.00	32	11.5
1671024	10.870	276	0.394	10.00	0.551	14.00	24	16.0
1671024LL	10.870	276	0.394	10.00	0.551	14.00	24	16.0
1671032	13.860	352	0.394	10.00	0.551	14.00	32	23.0
1671032LL	13.860	352	0.394	10.00	0.551	14.00	32	23.0
1671324	11.535	293	0.512	13.00	0.669	17.00	24	27.0
1671324LL	11.535	293	0.512	13.00	0.669	17.00	24	27.0
1671332	14.921	379	0.512	13.00	0.669	17.00	32	34.5
1671332LL	14.921	379	0.512	13.00	0.669	17.00	32	34.5
1671324L	13.800	350	0.512	13.00	0.669	17.00	24	27.0
1671332L	17.756	451	0.512	13.00	0.669	17.00	32	34.5
1671012-0832	16.102	409	0.394 - 0.315	10.00 - 8.00	0.551 - 0.472	14.00 - 12.00	12 + 32	19.0
1671312-1032	19.646	499	0.512 - 0.394	13.00 - 10.00	0.669 - 0.551	17.00 - 14.00	12 + 32	37.5

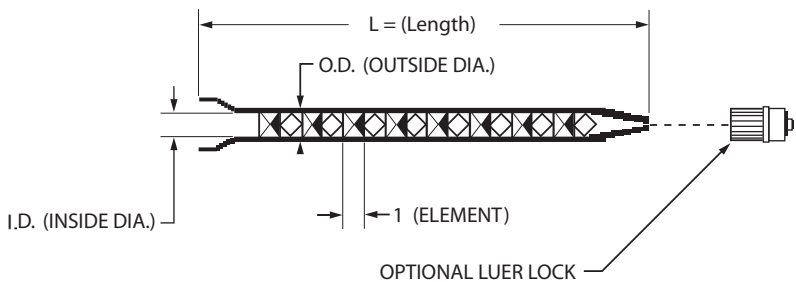

## ME Blue Series Static-Mixers 0.625" (15.9mm)

The part numbers reflect the bell-mouth, I.D. and the number of elements. Example: 1590524 = a bell-mouth of 15.9mm, an I.D. of 5mm, and 24 mixing elements. 1590524LL is the same item but fitted with a luer lock adapter. Sold in packages of 10.

Part Number	Length (inches)	Length (mm)	Inside Diam. (Inch)	Inside Diam. (mm)	Outside Diam. (Inch)	Outside Diam. (mm)	Number of Elements	Content Volume (ml)
1590524	5.870	149	0.197	5.00	0.315	8.00	24	2.3
1590524LL	5.870	149	0.197	5.00	0.315	8.00	24	2.3
1590532	7.400	188	0.197	5.00	0.315	8.00	32	2.8
1590532LL	7.400	188	0.197	5.00	0.315	8.00	32	2.8
1590624	7.320	186	0.250	6.35	0.394	10.00	24	4.2
1590624LL	7.320	186	0.250	6.35	0.394	10.00	24	4.2
1590632	9.252	235	0.250	6.35	0.394	10.00	32	6.6
1590632LL	9.252	235	0.250	6.35	0.394	10.00	32	6.6
1590648	13.150	334	0.250	6.35	0.413	10.50	48	10.0
1590648LL	13.150	334	0.250	6.35	0.413	10.50	48	10.0
1590824	8.780	223	0.315	8.00	0.472	12.00	24	8.5
1590824LL	8.780	223	0.315	8.00	0.472	12.00	24	8.5
1590832	11.300	287	0.315	8.00	0.472	12.00	32	11.5
1590832LL	11.300	287	0.315	8.00	0.472	12.00	32	11.5
1591024	10.870	276	0.394	10.00	0.551	14.00	24	16.0
1591024LL	10.870	276	0.394	10.00	0.551	14.00	24	16.0
1591032	13.860	352	0.394	10.00	0.551	14.00	32	23.0
1591032LL	13.860	352	0.394	10.00	0.551	14.00	32	23.0
1591324	11.535	293	0.512	13.00	0.669	17.00	24	27.0
1591324LL	11.535	293	0.512	13.00	0.669	17.00	24	27.0
1591332	14.921	379	0.512	13.00	0.669	17.00	32	34.5
1591332LL	14.921	379	0.512	13.00	0.669	17.00	32	34.5
1591324L	13.800	350	0.512	13.00	0.669	17.00	24	27.0
1591332L	17.756	451	0.512	13.00	0.669	17.00	32	34.5
1591012-0832	16.102	409	0.394 - 0.315	10.00 - 8.00	0.551 - 0.472	14.00 - 12.00	12 + 32	19.0
1591312-1032	19.646	499	0.512 - 0.394	13.00 - 10.00	0.669 - 0.551	17.00 - 14.00	12 + 32	37.5

## **Fisnar**

### **Global Headquarters**

15 Corporate Drive - Wayne - NJ 07470  
Tel: (973) 646-5044 E-mail: [info@fisnar.com](mailto:info@fisnar.com)  
[www.fisnar.com](http://www.fisnar.com)

## **Fisnar Europe**

### **European Headquarters**

2 Langlands Ave. - Kelvin South Business Park  
East Kilbride - Glasgow - G75 0YG  
Tel: +00 44 (0) 1355 577 222 E-mail: [infoeurope@fisnar.com](mailto:infoeurope@fisnar.com)  
[www.fisnareurope.co.uk](http://www.fisnareurope.co.uk)

## **Fisnar Asia**

### **Asia Headquarters**

Unit 2505-6, 25th Floor Prosperity Center  
25 Chong Yip St. - Kwun Tong, Kowloon - Hong Kong  
Tel: 852-2389-2827 E-mail: [info@fisnar.com.hk](mailto:info@fisnar.com.hk)  
[www.fisnar.com](http://www.fisnar.com) - [www.fisnar.com.cn](http://www.fisnar.com.cn)



**FISNAR**<sup>®</sup>